



Stavros[®]

Ценителям мастерства



КАПИТЕЛИ,
ПИЛЯСТРЫ, КОЛОННЫ

art. KL-043.01

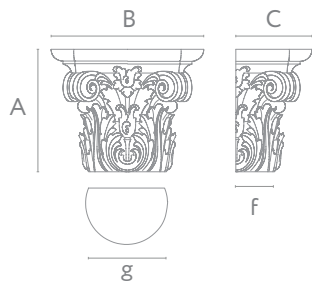

A	B	C	f	g	
250	254	151	87	126	mm

art. KL-013.1

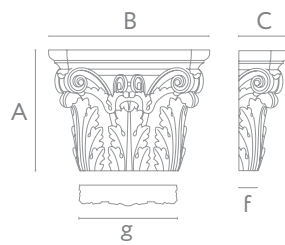

A	B	C	f	g	
90	120	37	14	73	mm
113	150	46	18	91	mm
136	181	56	22	110	mm
158	210	65	25	128	mm
188	250	77	30	152	mm

art. KL-001

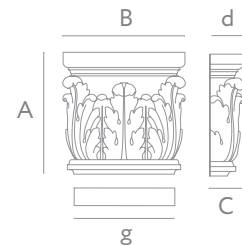

A	B	C	d	f	g	
90	90	25	25	13	74	mm
110	110	31	30	16	91	mm
130	130	36	35	19	107	mm
160	160	45	43	23	132	mm
180	180	51	49	26	149	mm
220	220	62	60	32	182	mm

art. KL-001.02

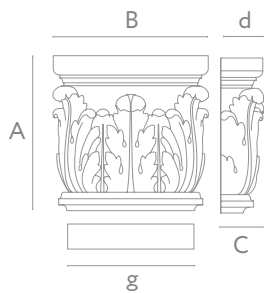

A	B	C	d	f	g	
65	65	24	24	18	54	mm
90	90	26	26	18	74	mm
130	130	31	31	20	107	mm
167	167	39	39	25	138	mm
194	194	42	42	25	160	mm
220	220	55	55	36	182	mm

KL-001.02
65*65*24
Капитель

KL-001.02
90*90*26

KL-001.02
130*130*31

KL-001.02
167*167*39

KL-001.02
194*194*42

KL-001.02
220*220*55

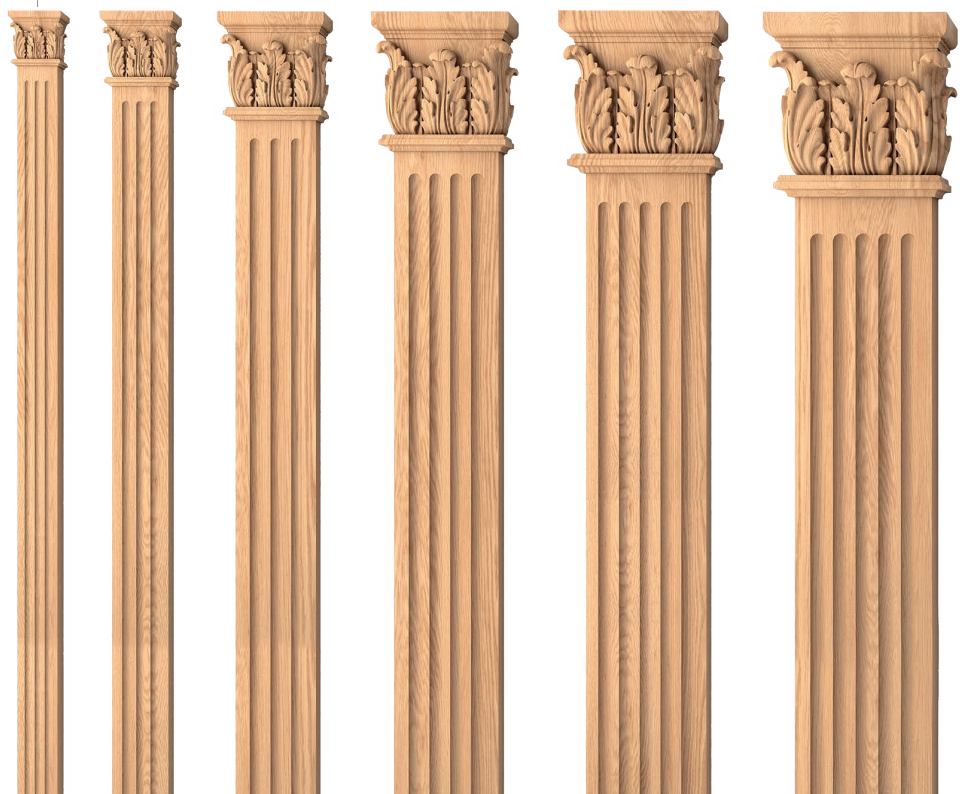

Пилястра

PLM-014

PLM-015

PLM-016

PLM-017

PLM-018

PLM-019

art. KL-024

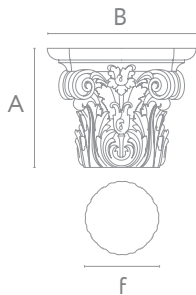

A	B	C	f	
104	130	130	66	mm
128	160	160	81	mm
152	190	190	96	mm
170	212	212	107	mm
208	260	260	132	mm
249	310	310	156	mm
289	360	360	182	mm
361	450	450	227	mm

art. KL-038

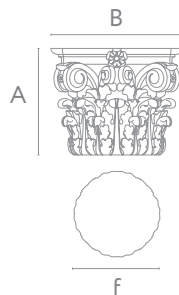

A	B	C	f	
114	140	140	92	mm
130	160	160	105	mm
146	180	180	118	mm
162	200	200	131	mm
195	240	240	158	mm
227	280	280	184	mm
276	340	340	223	mm

art. KL-016

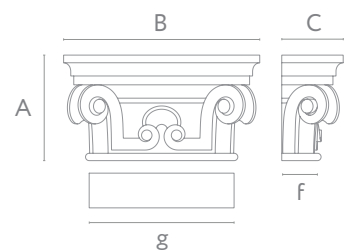

A	B	C	f	g	
64	120	37	21	87	mm
80	150	47	26	109	mm
91	170	53	30	123	mm
107	200	62	35	145	mm
128	240	74	42	174	mm

art. KL-043

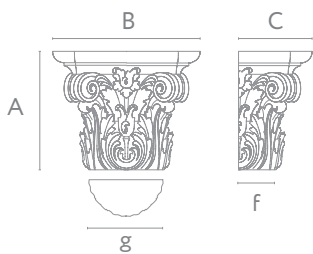

A	B	C	f	g	
104	130	65	32	66	mm
128	160	80	40	81	mm
152	190	95	48	96	mm
170	212	106	53	107	mm
208	260	130	66	132	mm
249	310	155	78	156	mm
289	360	180	91	182	mm
361	450	225	113	227	mm

art. KL-003

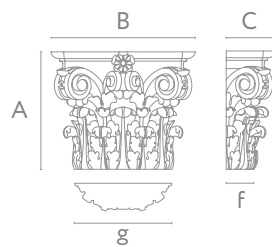

A	B	C	f	g	
114	140	48	26	94	mm
130	160	55	30	108	mm
146	180	62	34	121	mm
162	200	69	38	134	mm
195	240	83	45	161	mm
227	280	96	53	188	mm
276	340	117	64	229	mm

art. KL-022

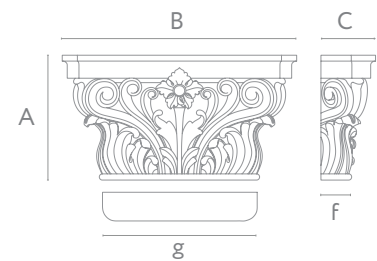

A	B	C	f	g	
76	142	34	17	92	mm
91	170	41	21	111	mm
107	200	48	24	131	mm
121	226	54	27	148	mm
139	260	62	31	171	mm
161	300	72	36	197	mm

art. KL-005

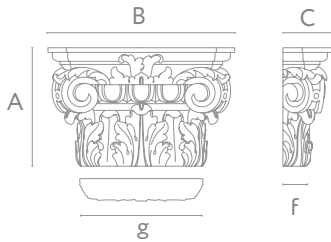

A	B	C	f	g	
76	120	31	14	78	mm
89	140	37	16	91	mm
101	160	42	18	104	mm
116	183	48	21	119	mm
133	210	55	24	137	mm
165	260	68	30	169	mm

art. KL-013

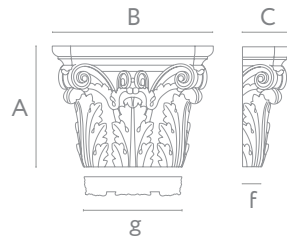

A	B	C	f	g	
90	120	37	14	73	mm
113	150	46	18	91	mm
158	210	65	25	128	mm

art. KL-012

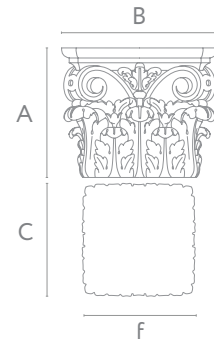

A	B	C	f	
125	150	150	107	mm
150	180	180	129	mm
170	205	205	146	mm
192	231	231	165	mm
216	260	260	186	mm
266	320	320	229	mm
316	380	380	271	mm

art. KL-017

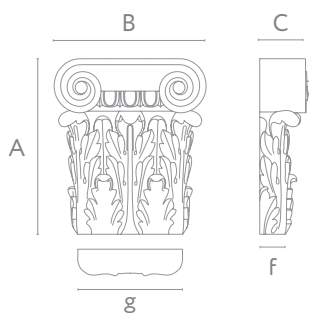

A	B	C	f	g	
115	100	35	17	69	mm
138	120	41	21	83	mm
160	139	48	24	96	mm
196	170	59	29	117	mm
230	200	69	35	138	mm

art. KL-058

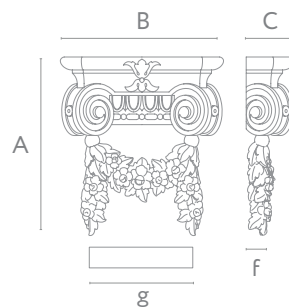

A	B	C	g	f	
179	167	50	100	20	mm
232	217	64	130	26	mm
268	251	74	150	30	mm
304	284	84	170	34	mm
357	334	99	200	40	mm

art. KL-034

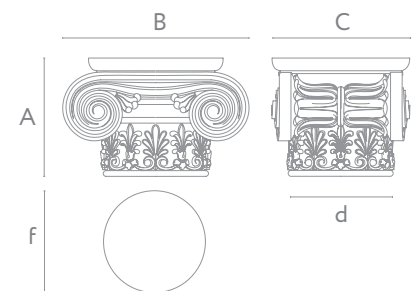

A	B	C	d	f	
115	180	133	130	97	mm
137	215	159	155	116	mm
159	250	185	180	135	mm

art. KL-011

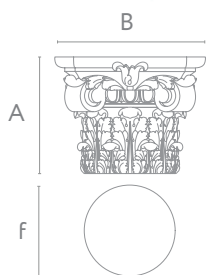
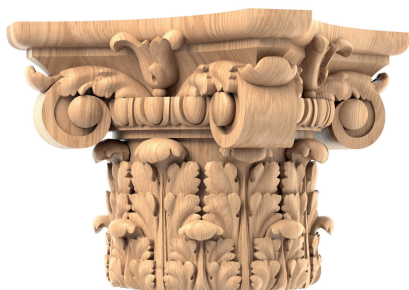

A	B	C	f	
117	150	150	94	mm
132	170	170	107	mm
150	193	193	121	mm
187	240	240	151	mm
218	280	280	176	mm
249	320	320	201	mm
280	360	360	227	mm

art. KL-039

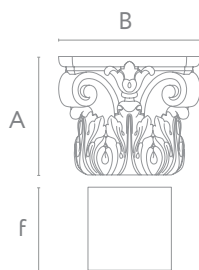

A	B	C	f	
60	72	72	42	mm
68	82	82	48	mm
83	99	99	58	mm
91	110	110	65	mm
108	130	130	77	mm
125	150	150	88	mm
141	170	170	100	mm
158	190	190	112	mm
182	220	220	130	mm
216	260	260	153	mm

art. KL-040

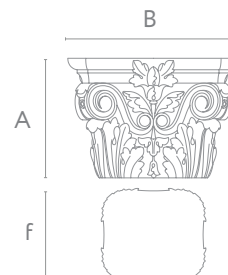

A	B	C	f	
63	90	90	57	mm
77	110	110	69	mm
91	130	130	82	mm
112	160	160	101	mm
133	190	190	120	mm
147	210	210	132	mm
168	240	240	151	mm
245	350	350	221	mm

art. KL-041

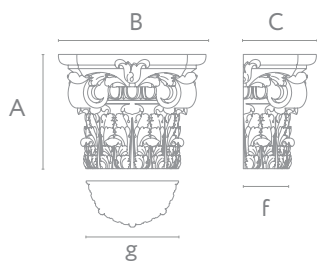

A	B	C	f	g	
117	150	75	47	94	mm
132	170	85	53	107	mm
150	193	97	60	121	mm
187	240	120	75	151	mm
218	280	140	88	176	mm
249	320	160	101	202	mm
280	360	180	109	227	mm

art. KL-004

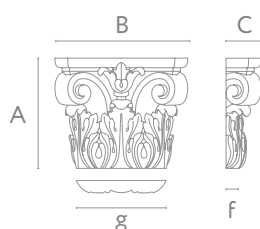

A	B	C	f	g	
60	72	19	7	48	mm
68	82	22	8	55	mm
83	99	27	10	66	mm
91	110	30	11	74	mm
108	130	35	13	87	mm
125	150	40	15	101	mm
141	170	46	17	114	mm
158	190	51	19	127	mm
182	220	59	22	148	mm
216	260	70	26	174	mm

art. KL-014

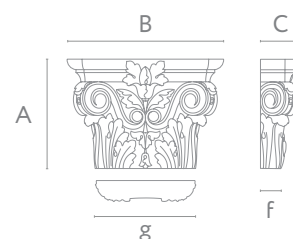

A	B	C	f	g	
63	90	25	12	57	mm
77	110	30	14	69	mm
91	130	36	17	82	mm
112	160	44	21	101	mm
133	190	52	25	120	mm
147	210	58	27	132	mm
168	240	66	31	151	mm
245	350	97	46	221	mm

art. KL-004.02

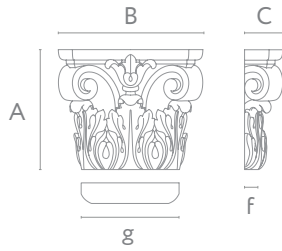

A	B	C	f	g	
68	82	32	19	54	mm
98	118	40	21	78	mm
135	162	47	25	108	mm
172	206	58	31	137	mm
196	236	63	33	157	mm
221	265	78	41	176	mm

KL-004.02

82*68*32
+BS-009
70*14*26

Капитель

База

KL-004.02
118*98*40
+BS-009
95*18*28

KL-004.02
162*135*47
+BS-009
130*22*29

KL-004.02
206*172*58
+BS-009
160*26*36

KL-004.02
236*196*63
+BS-009
180*26*36

KL-004.02
265*221*78
+BS-009
210*30*50

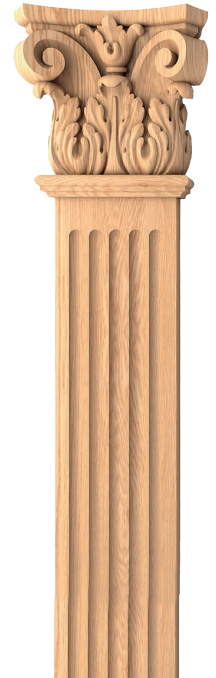
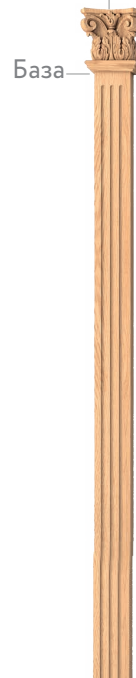

Пилястра
PLM-014

PLM-015

PLM-016

PLM-017

PLM-018

PLM-019

art. KL-014.02

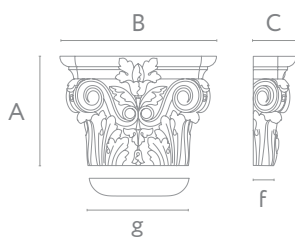

A	B	C	f	g	
63	90	36	22	61	mm
85	121	42	23	83	mm
115	165	48	24	112	mm
148	212	61	28	144	mm
170	243	66	29	165	mm
195	279	84	41	189	mm

KL-014.02

90*63*36
+BS-009
70*14*26

Капитель

База

KL-014.02
121*85*42
+BS-009
95*18*28

KL-014.02
165*115*47
+BS-009
130*22*29

KL-014.02
212*148*61
+BS-009
160*26*36

KL-014.02
243*170*66
+BS-009
180*26*36

KL-014.02
279*195*84
+BS-009
210*30*50

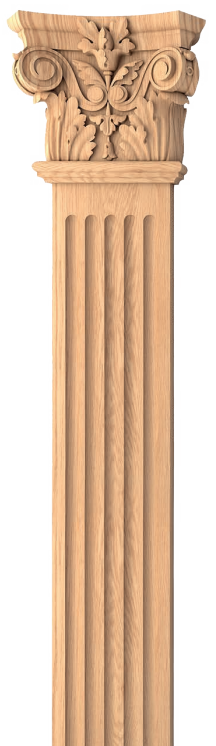
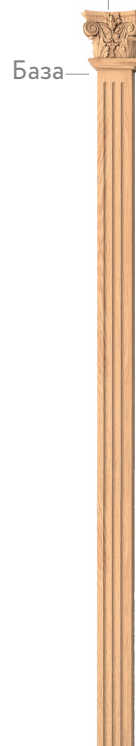

Пилястра
PLM-014

PLM-015

PLM-016

PLM-017

PLM-018

PLM-019

art. KL-060

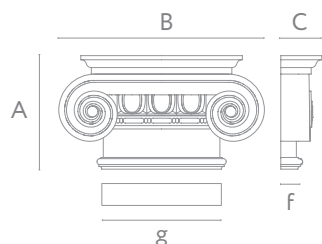

A	B	C	f	g	
68	123	32	18	74	mm
97	176	38	18	104	mm
127	229	48	22	135	mm
146	264	53	22	154	mm
165	300	65	32	175	mm

art. KL-010

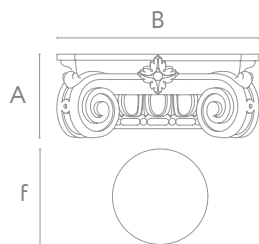

A	B	C	f	
63	150	150	101	mm
70	168	168	113	mm
83	200	200	134	mm
104	250	250	168	mm
125	300	300	201	mm
146	350	350	235	mm

art. KL-059

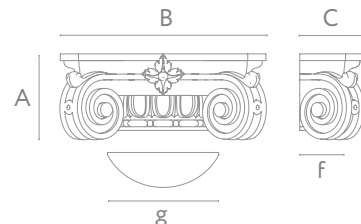

A	B	C	f	g	
70	168	52	29	92	mm
83	200	62	35	110	mm
104	250	78	43	138	mm
125	300	94	52	165	mm
146	350	109	60	192	mm

art. KL-033

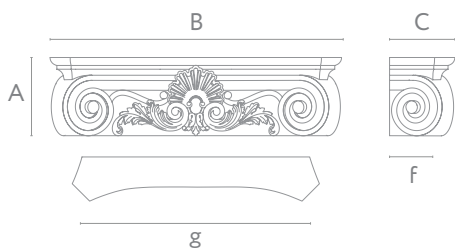

A	B	C	f	g	
67	250	56	26	198	mm
78	290	65	30	230	mm
91	340	76	36	270	mm

art. KL-006

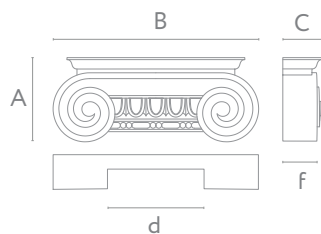

A	B	C	d	f	
57	140	27	66	23	mm
64	156	30	73	26	mm
74	180	35	85	30	mm
86	210	40	99	35	mm
98	240	46	113	40	mm
119	290	56	136	48	mm

art. KL-008

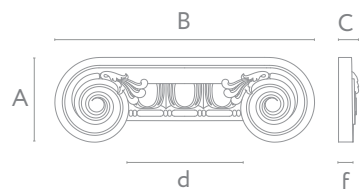

A	B	C	d	f	
59	180	14	81	10	mm
68	210	16	95	11	mm
75	230	18	104	12	mm
84	258	20	116	14	mm
98	300	23	135	16	mm
117	360	28	162	20	mm

art. KL-029

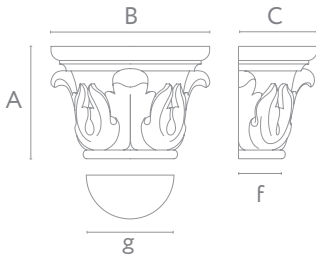

A	B	C	f	g	
50	70	35	19	38	mm
57	80	40	22	44	mm
65	91	45	25	50	mm
79	110	55	30	60	mm
93	130	65	36	71	mm
114	160	80	44	88	mm

art. KL-050

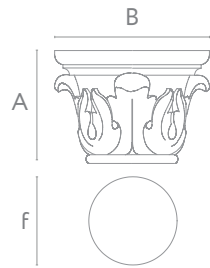

A	B	C	f	
50	70	70	38	mm
57	80	80	44	mm
65	91	91	50	mm
79	110	110	60	mm
93	130	130	72	mm
114	160	160	88	mm

art. KL-025

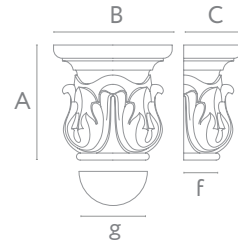

A	B	C	f	g	
68	70	35	20	39	mm
82	85	43	24	48	mm
97	100	50	28	56	mm
116	120	60	34	67	mm
146	150	75	42	84	mm

art. KL-046

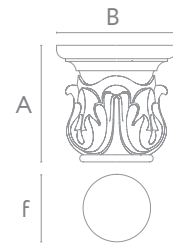

A	B	C	f	
68	70	70	40	mm
82	85	85	48	mm
97	100	100	56	mm
116	120	120	68	mm
146	150	150	84	mm

art. KL-030

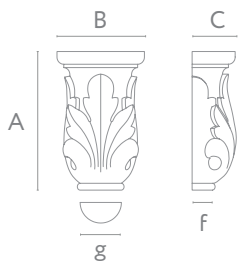

A	B	C	f	g	
78	50	25	12	23	mm
110	70	35	16	32	mm
133	85	42	20	39	mm
156	100	50	24	46	mm
188	120	60	28	56	mm

art. KL-051

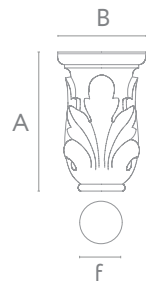

A	B	C	f	
78	50	50	24	mm
110	70	70	32	mm
133	85	85	40	mm
156	100	100	46	mm
188	120	120	56	mm

art. KL-031

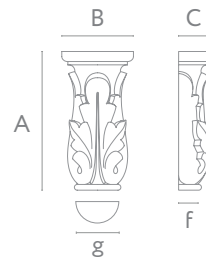

A	B	C	f	g	
98	50	25	14	28	mm
118	60	30	17	34	mm
145	74	37	21	42	mm
176	90	45	26	51	mm
215	110	55	31	62	mm
274	140	70	40	80	mm

art. KL-052



A	B	C	f	
98	50	50	28	mm
118	60	60	34	mm
145	74	74	42	mm
176	90	90	52	mm
215	110	110	62	mm
274	140	140	80	mm

art. KL-027

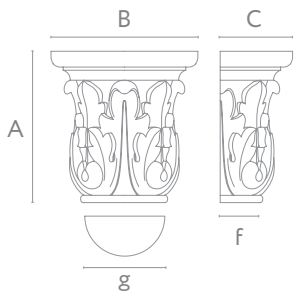

A	B	C	f	g	
72	70	35	20	39	mm
88	85	42	24	47	mm
102	99	49	28	55	mm
124	120	60	34	67	mm
144	140	70	39	78	mm
175	170	85	47	94	mm

art. KL-048

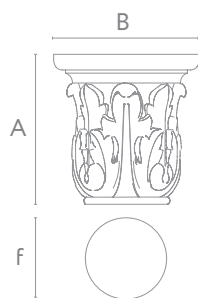

A	B	C	f	
72	70	70	40	mm
88	85	85	48	mm
102	99	99	56	mm
124	120	120	68	mm
144	140	140	76	mm
175	170	170	95	mm

art. KL-009

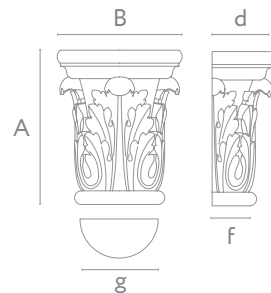

A	B	C	d	f	g	
80	65	33	32	20	40	mm
90	73	38	36	22	45	mm
100	81	42	40	25	50	mm
110	89	46	44	27	55	mm
120	98	50	48	30	60	mm
140	114	59	56	34	70	mm

art. KL-045

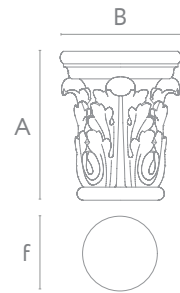

A	B	C	f	
80	65	65	40	mm
90	73	73	44	mm
100	81	81	50	mm
110	89	89	54	mm
120	98	98	60	mm
140	114	114	68	mm

art. KL-026

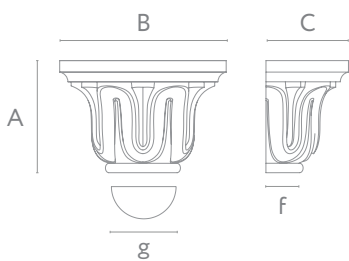

A	B	C	f	g	
47	70	35	15	29	mm
57	85	42	18	35	mm
68	101	50	21	42	mm
81	120	60	25	50	mm
94	140	70	29	58	mm
114	170	86	35	70	mm

art. KL-047

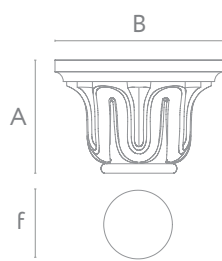

A	B	C	f	
47	70	70	30	mm
57	85	85	36	mm
68	101	101	42	mm
81	120	120	50	mm
94	140	140	58	mm
114	170	170	70	mm

art. KL-028

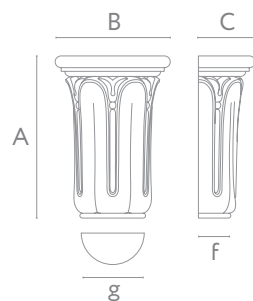

A	B	C	f	g	
110	79	39	21	42	mm
139	100	50	26	53	mm
167	120	60	32	64	mm
195	140	70	37	74	mm

art. KL-049

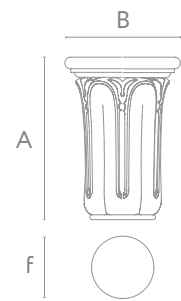

A	B	C	f	
110	79	79	42	mm
139	100	100	54	mm
167	120	120	64	mm
195	140	140	74	mm

art. KL-007

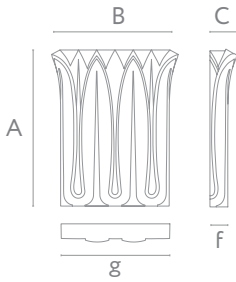
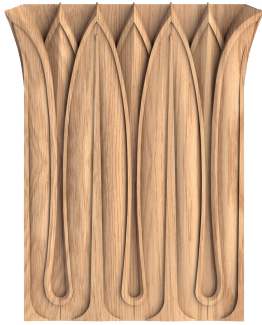

A	B	C	F	G	
74	60	13	9	52	mm
99	80	17	12	69	mm
124	100	21	14	86	mm
151	122	26	18	105	mm
173	140	30	20	121	mm

art. KL-015

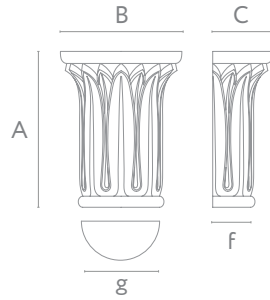
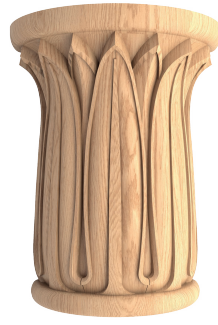

A	B	C	F	G	
103	80	40	25	51	mm
122	95	48	30	60	mm
141	110	55	35	70	mm
167	130	65	41	83	mm
192	150	75	48	95	mm

art. KL-044

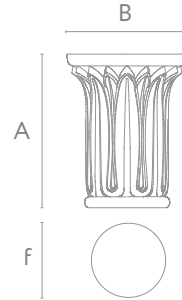

A	B	C	F	
103	80	80	51	mm
122	95	95	60	mm
141	110	110	70	mm
167	130	130	83	mm
192	150	150	95	mm

art. KL-020

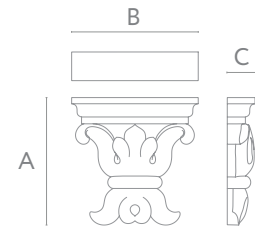

A	B	C	
50	50	11	mm

art. KL-037.01

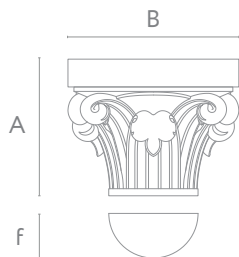

A	B	C	F	
80	100	50	26	mm
100	125	63	33	mm
120	150	75	39	mm
144	180	90	47	mm

art. KL-037

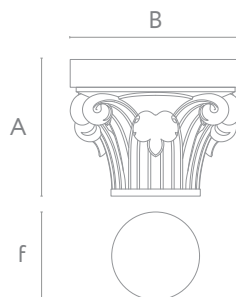

A	B	F	
80	100	52	mm
100	125	65	mm
120	150	78	mm
144	180	94	mm

art. KL-036

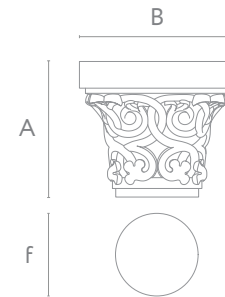

A	B	F	
110	126	67	mm
131	150	80	mm
160	183	98	mm
200	229	122	mm

art. KL-032

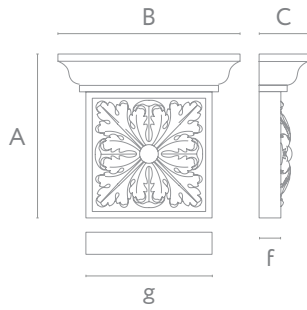

A	B	C	F	g	
72	80	22	10	56	mm
90	100	27	12	69	mm
104	115	32	14	80	mm
127	140	39	17	97	mm
145	160	44	19	111	mm
172	190	53	23	132	mm

art. KL-057

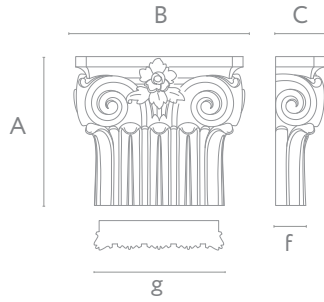

A	B	C	F	g	
115	132	38	22	90	mm
138	158	45	27	108	mm
172	198	57	33	135	mm

art. KL-056

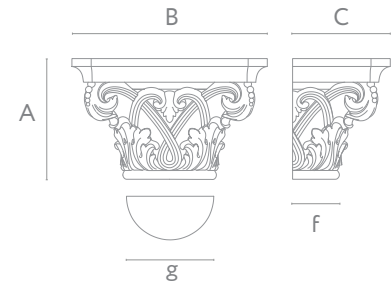

A	B	C	F	g	
107	173	87	41	75	mm
137	221	111	53	96	mm
171	277	138	66	120	mm

art. KL-054

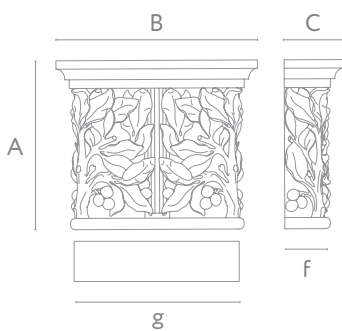

A	B	C	F	g	
109	130	38	26	105	mm
159	190	56	38	153	mm
218	260	77	52	209	mm

art. KL-055

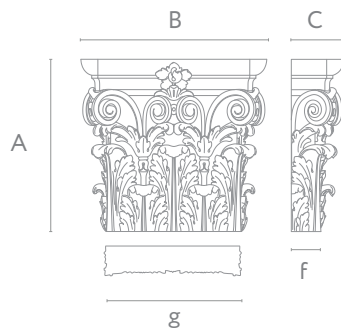

A	B	C	F	g	
191	206	58	33	147	mm
230	248	70	39	176	mm
255	275	77	43	195	mm

art. KL-023

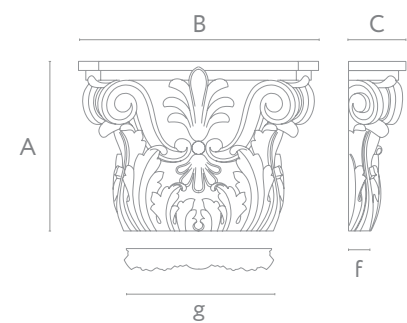

A	B	C	F	g	
85	120	29	11	75	mm
106	150	37	14	93	mm
127	180	44	17	112	mm
149	210	52	20	131	mm
167	236	58	22	147	mm
205	290	71	27	181	mm



art. KL-062

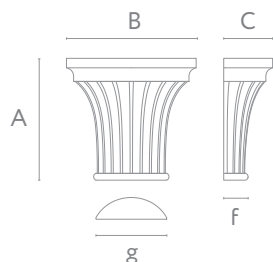

A	B	C	F	g	
155	165	62	28	90	mm
172	183	69	31	100	mm
207	220	83	37	120	mm
224	238	90	40	130	mm
258	275	104	48	150	mm
310	330	125	55	180	mm
379	403	152	68	220	mm

KL-062 155*165*62 KL-062 172*183*69 KL-062 207*220*83 KL-062 224*238*90 KL-062 258*275*104 KL-062 310*330*125 KL-062 379*403*152

Капитель

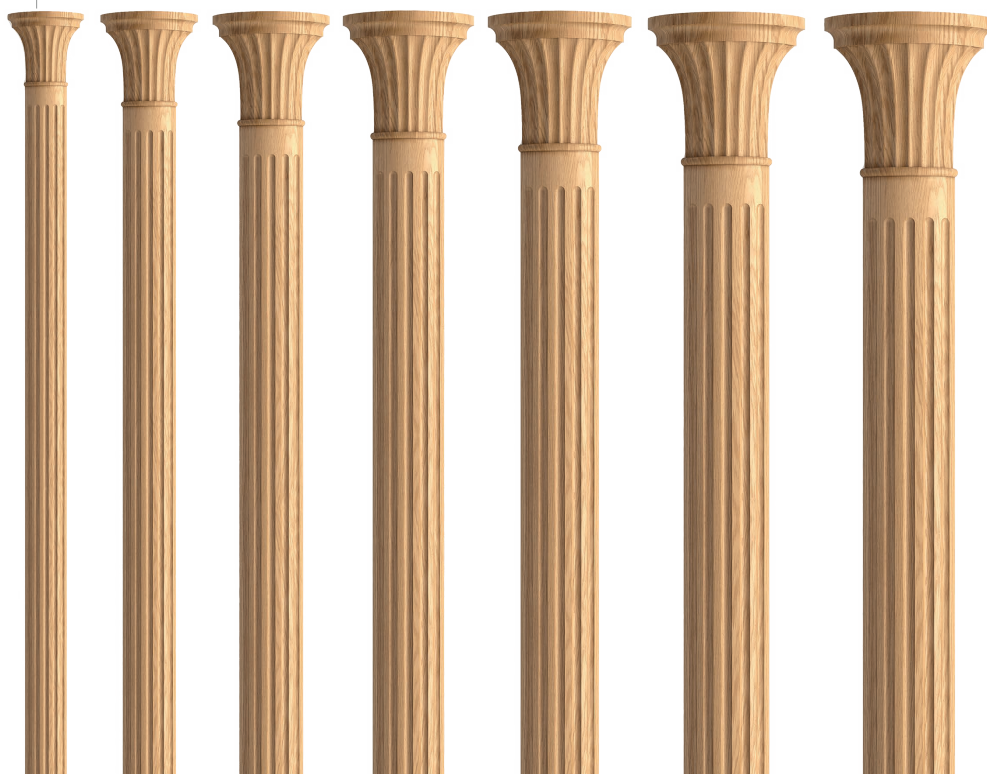

Пилястра

PLM-020 2130*90*28 PLM-020 2110*100*31 PLM-020 2080*120*37 PLM-020 2050*130*40 PLM-020 2350*150*46 PLM-020 2280*180*55 PLM-020 2180*220*68

art. KL-064

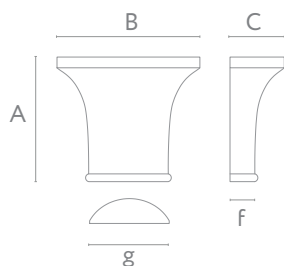

A	B	C	F	g	
144	165	63	29	92	mm
160	183	70	32	102	mm
191	219	83	38	122	mm
207	237	90	41	132	mm
238	273	104	47	152	mm
285	327	124	57	182	mm
348	399	151	69	222	mm

KL-064 144*165*63 KL-064 160*183*70 KL-064 191*219*83 KL-064 207*237*90 KL-064 238*273*104 KL-064 285*327*124 KL-064 348*399*151

Капитель

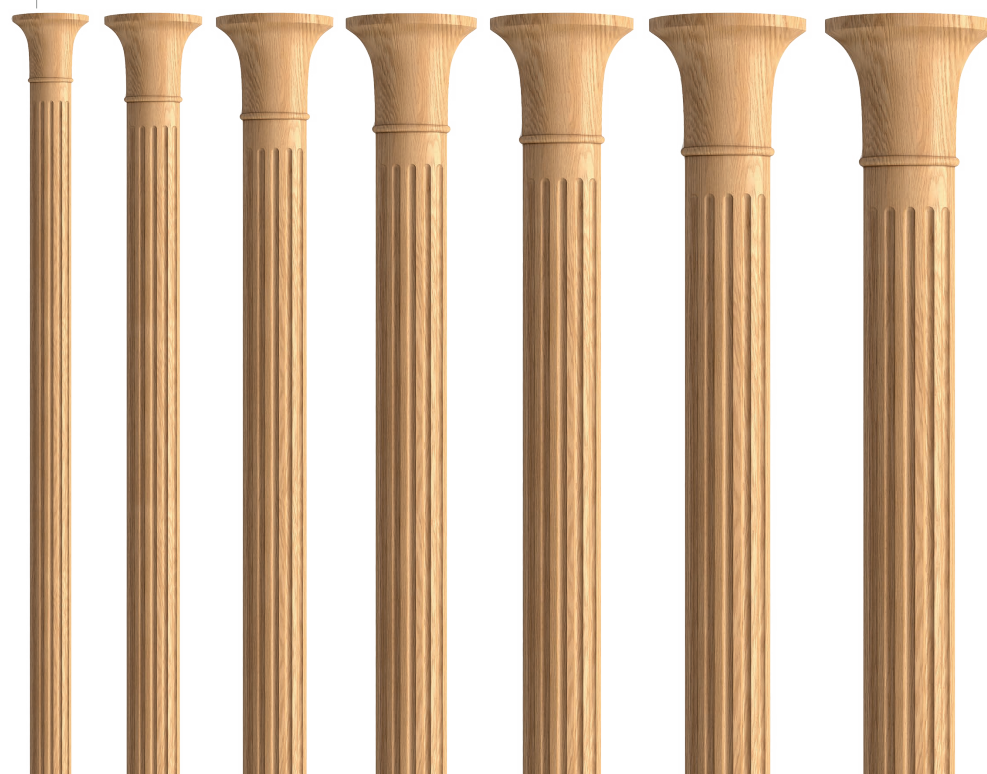

Пилястра

PLM-020 2130*90*28 PLM-020 2110*100*31 PLM-020 2080*120*37 PLM-020 2050*130*40 PLM-020 2350*150*46 PLM-020 2280*180*55 PLM-020 2180*220*68

art. KL-066

KL-066 112*188*74 KL-066 123*208*81 KL-066 146*246*97 KL-066 158*265*103 KL-066 180*304*119 KL-066 215*361*139 KL-066 260*438*170

Капитель

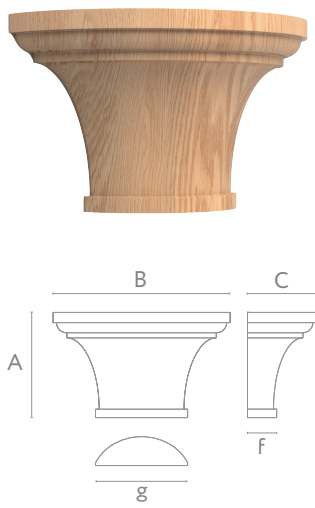

A	B	C	f	g	
112	188	74	32	98	mm
123	208	81	35	108	mm
146	246	97	41	128	mm
158	265	103	44	138	mm
180	304	119	50	158	mm
215	361	139	59	188	mm
260	438	170	72	228	mm

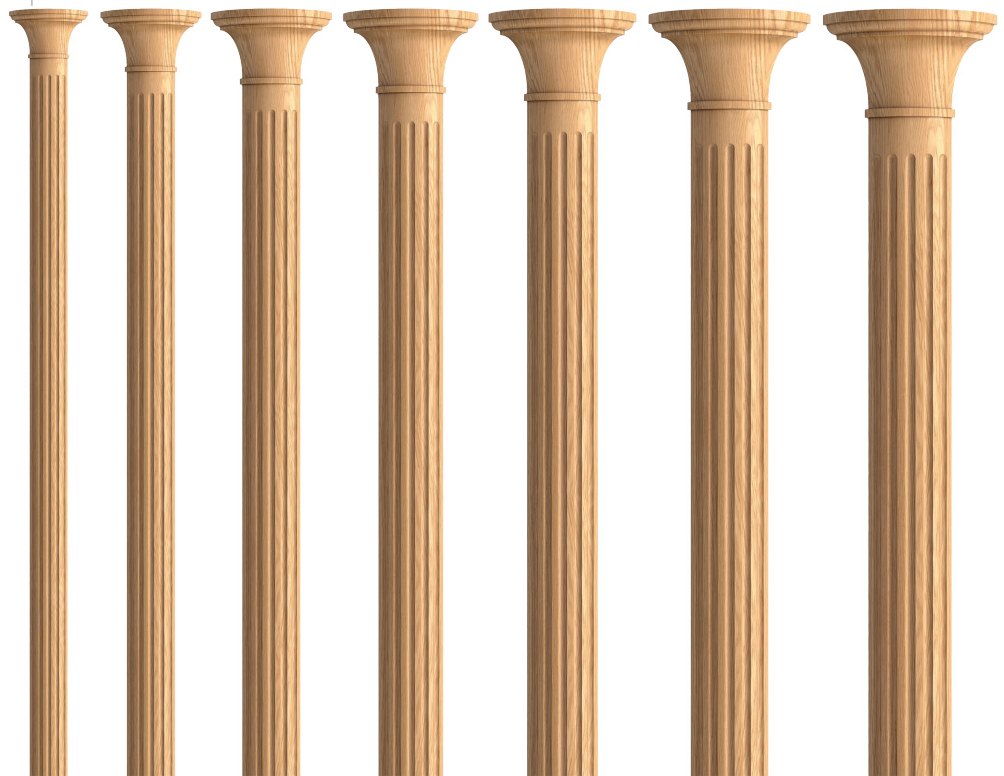

Пилястра

PLM-020 2130*90*28 PLM-020 2110*100*31 PLM-020 2080*120*37 PLM-020 2050*130*40 PLM-020 2350*150*46 PLM-020 2280*180*55 PLM-020 2180*220*68



art. KL-061

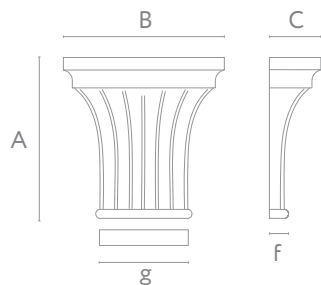

A	B	C	f	g	
90	90	36	16	50	mm
126	126	45	16	70	mm
180	180	57	16	100	mm
234	234	72	20	130	mm
270	270	80	20	150	mm
306	306	98	30	170	mm

KL-061 90°90°36	KL-061 126°126°45	KL-061 180°180°57	KL-061 234°234°72	KL-061 270°270°80	KL-061 306°306°98
Капитель					
Пиластра					
PLM-021 2000°50°16	PLM-021 2000°70°16	PLM-021 2000°100°16	PLM-021 2000°130°20	PLM-021 2000°150°20	PLM-021 2000°170°30

art. KL-063

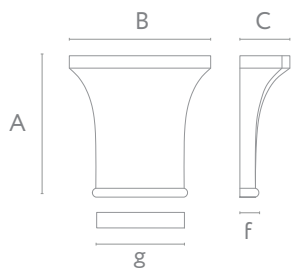

A	B	C	f	g	
80	80	35	16	50	mm
112	112	44	16	70	mm
160	160	55	16	100	mm
208	208	71	20	130	mm
240	240	78	20	150	mm
272	272	96	30	170	mm

KL-063 80°80°35	KL-063 112°112°44	KL-063 160°160°55	KL-063 208°208°71	KL-063 240°240°78	KL-063 272°272°96
Капитель					
Пиластра					
PLM-021 2000°50°16	PLM-021 2000°70°16	PLM-021 2000°100°16	PLM-021 2000°130°20	PLM-021 2000°150°20	PLM-021 2000°170°30

art. KL-065

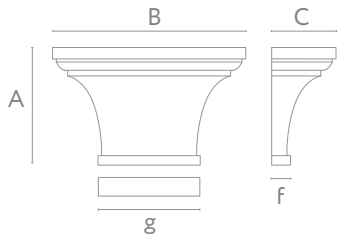

A	B	C	F	g	
62	102	42	18	54	mm
85	140	51	18	74	mm
120	197	64	18	104	mm
154	253	83	22	134	mm
177	291	91	22	154	mm
200	329	109	32	174	mm

KL-065
62*102*42
Капитель

KL-065
85*140*51

KL-065
120*197*64

KL-065
154*253*83

KL-065
177*291*91

KL-065
200*329*109



Пилястра
PLM-021
2000*50*16

PLM-021
2000*70*16

PLM-021
2000*100*16

PLM-021
2000*130*20

PLM-021
2000*150*20

PLM-021
2000*170*30

art. KL-067

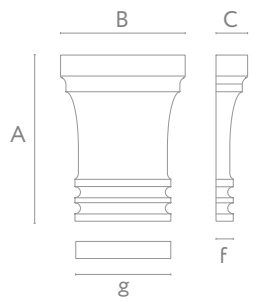

A	B	C	F	g	
95	70	26	18	54	mm
148	109	30	18	84	mm
190	140	34	18	108	mm
243	179	43	22	138	mm
279	205	46	22	158	mm
314	238	59	32	178	mm

KL-067
95*70*26
Капитель

KL-067
148*109*30

KL-067
190*140*34

KL-067
243*179*43

KL-067
279*205*46

KL-063
314*238*59



Пилястра
PLM-021
2000*50*16

PLM-021
2000*70*16

PLM-021
2000*100*16

PLM-021
2000*130*20

PLM-021
2000*150*20

PLM-021
2000*170*30

art. PLM-021



A	B	C	
1000	50	16	mm
1000	70	16	mm
1000	100	16	mm
1000	130	20	mm
1000	150	20	mm
1000	170	30	mm
2000	50	16	mm
2000	70	16	mm
2000	100	16	mm
2000	130	20	mm
2000	170	30	mm

art. PLM-022

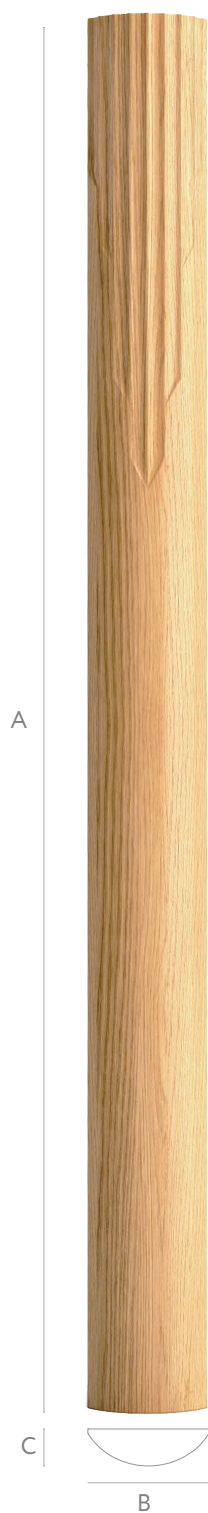

A	B	C	
1000	87	27	mm
1000	96	30	mm
1000	116	36	mm
1000	125	39	mm
1000	144	44	mm
1000	173	53	mm
1000	212	65	mm
2000	87	27	mm
2000	96	30	mm
2000	116	36	mm
2000	125	39	mm
2000	144	44	mm
2000	173	53	mm
2000	212	65	mm



art. PLM-014

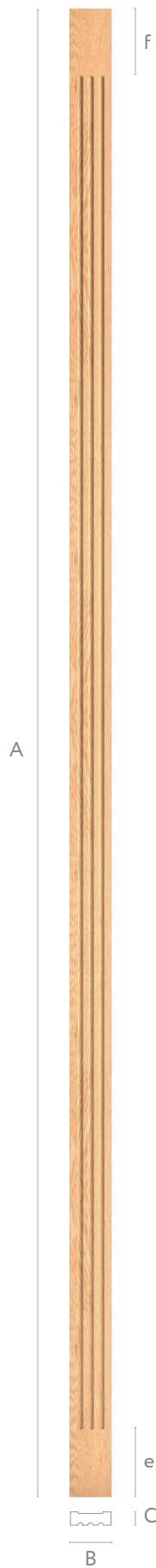

A	B	C	e	f	mm
720	50	16	50	50	mm
1300	50	16	100	100	mm
1650	50	16	100	100	mm
2200	50	16	100	100	mm

art. RS-001 Соединительная розетка

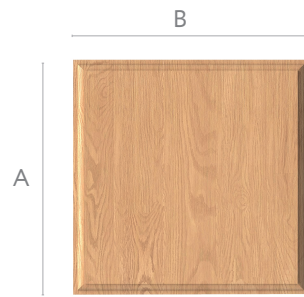

A	B	C	mm
50	50	24	mm
55	55	24	mm
70	70	24	mm
80	80	24	mm
100	100	24	mm
105	105	24	mm



art. RS-002 Соединительная розетка

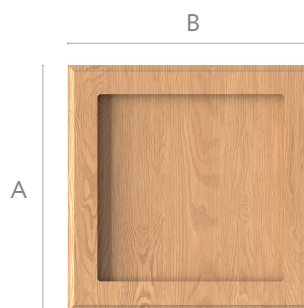

A	B	C	mm
50	50	24	mm
65	65	24	mm
75	75	24	mm
100	100	24	mm
105	105	24	mm



art. RS-003 Соединительная розетка

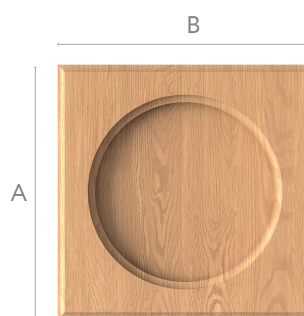

A	B	C	mm
50	50	24	mm
70	70	24	mm
75	75	24	mm
100	100	24	mm
105	105	24	mm



art. PLM-016



A	B	C	e	f	
900	100	16	120	120	mm
1300	100	16	120	120	mm
1650	100	16	120	120	mm
2200	100	16	120	120	mm

art. BS-009 База



A	B	C	f	g	
70	14	26	20	58	mm
95	18	28	20	78	mm
130	22	29	20	108	mm
160	26	36	25	140	mm
180	26	36	25	160	mm
210	30	50	37	185	mm

art. PLM-015

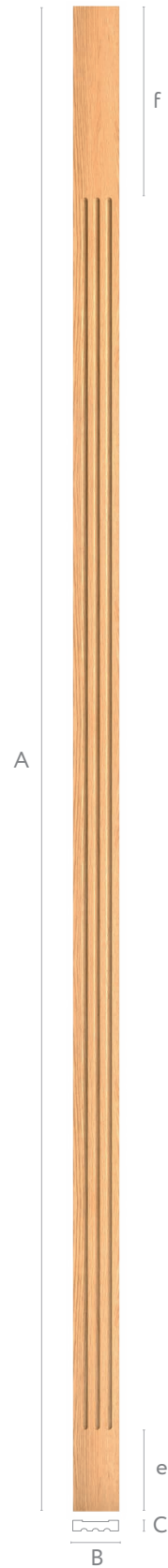

A	B	C	e	f	
2200	70	16	120	280	mm

art. PLM-016.1

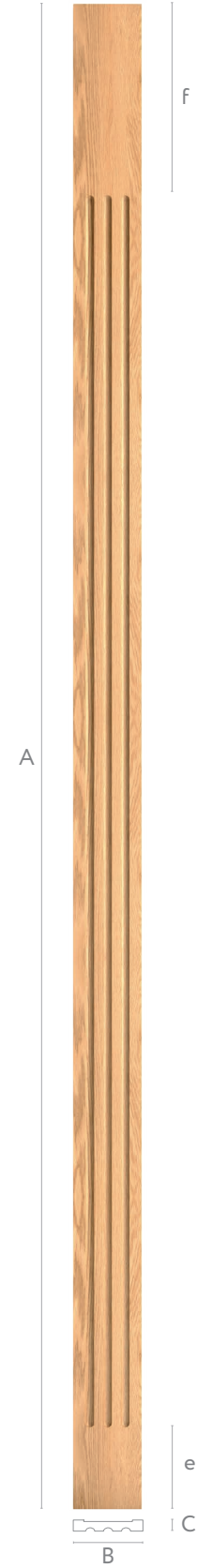

A	B	C	e	f	
2200	100	16	120	280	mm

art. PLM-017

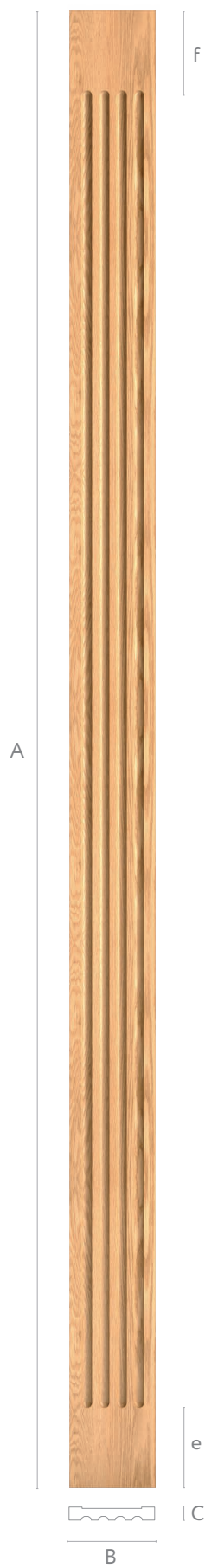

A	B	C	e	f	
2200	130	20	120	120	mm

art. PLM-018

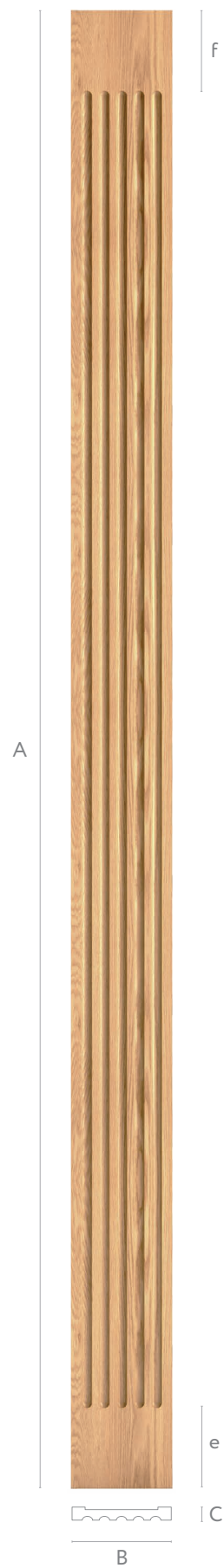

A	B	C	e	f	
2200	150	20	120	120	mm

art. PLM-019

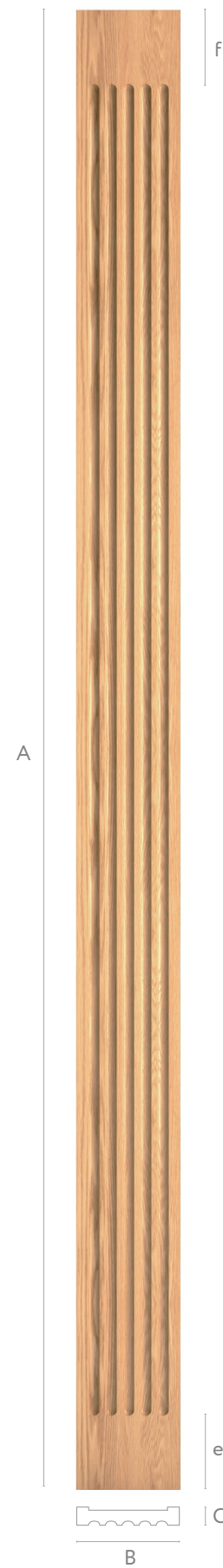

A	B	C	e	f	
2400	170	30	120	120	mm

art. RS-004 Соединительная розетка

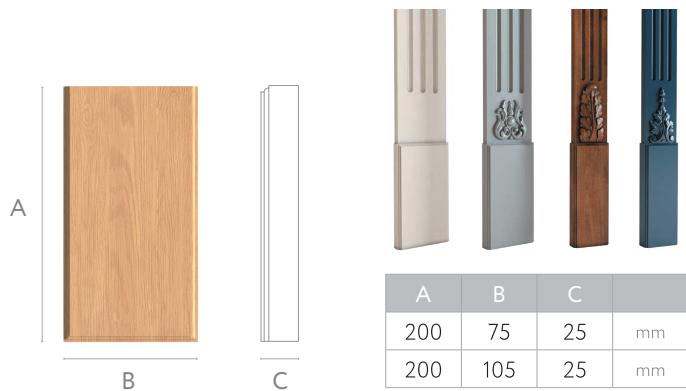

art. BS-001 База

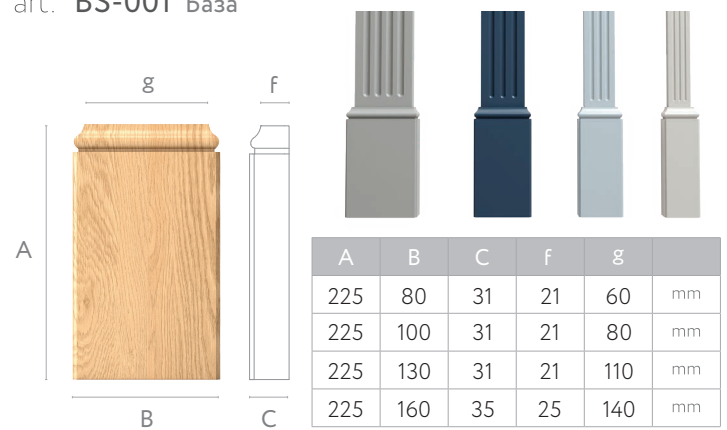

art. BS-002 База

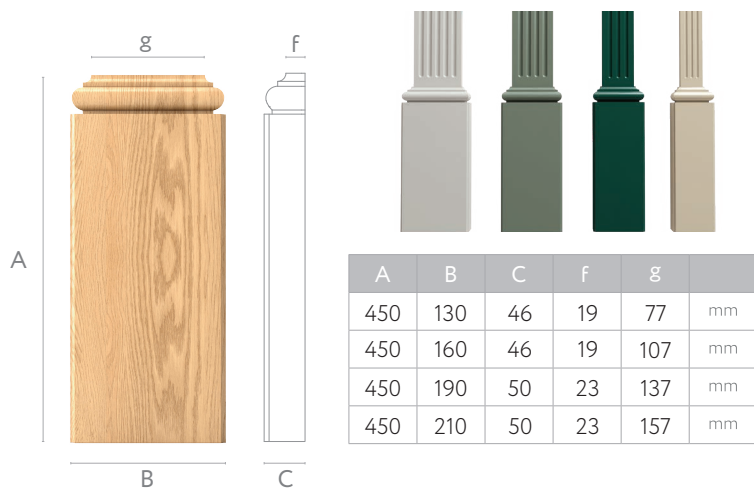

art. BS-003 База

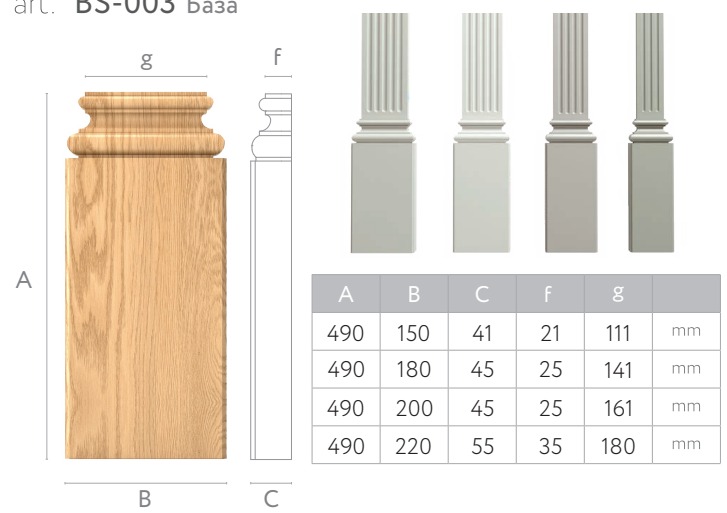

art. BS-004 База

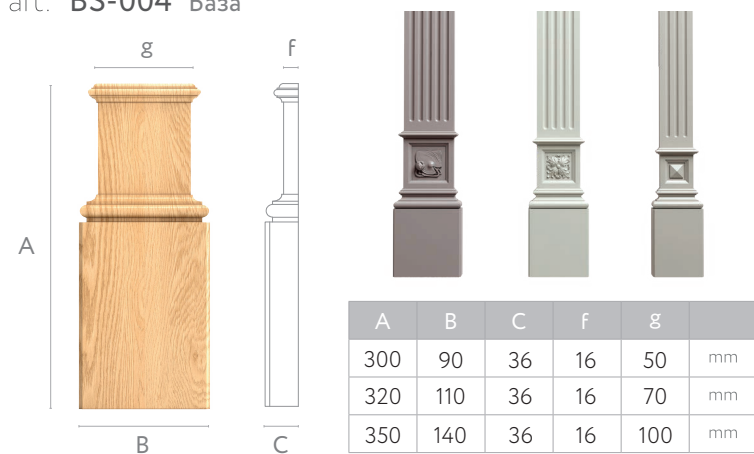

art. BS-008 База

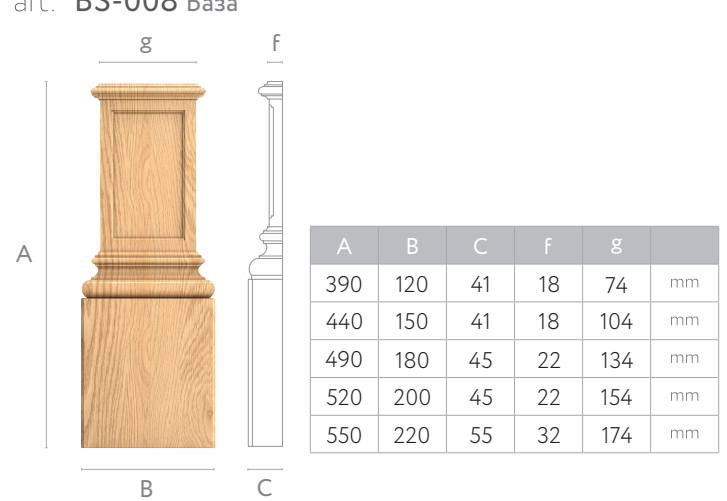

art. BS-007 База

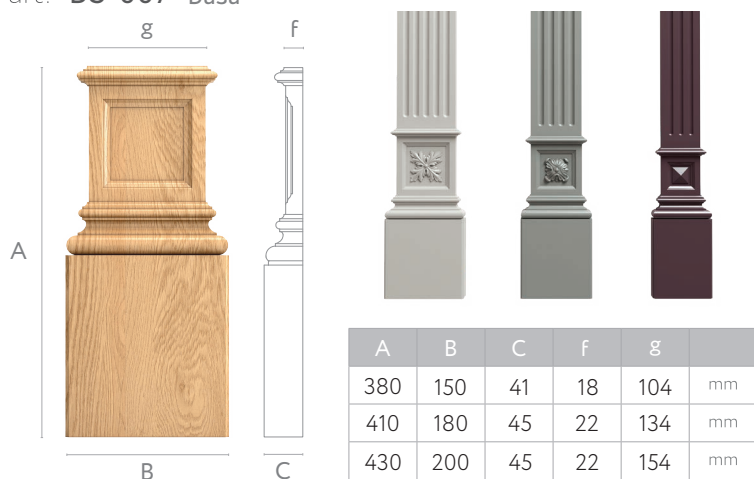

art. PLM-020

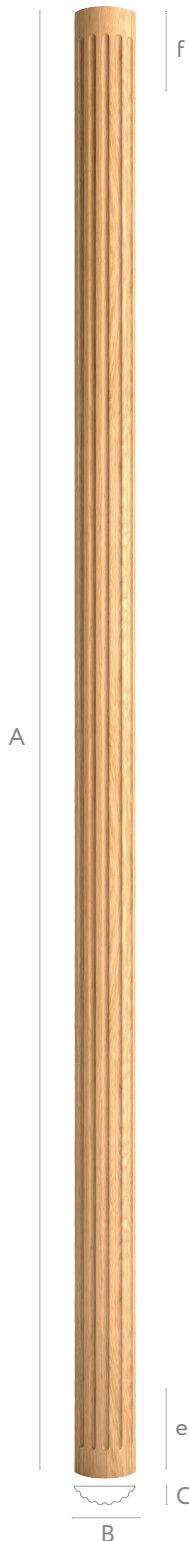

art. BS-006

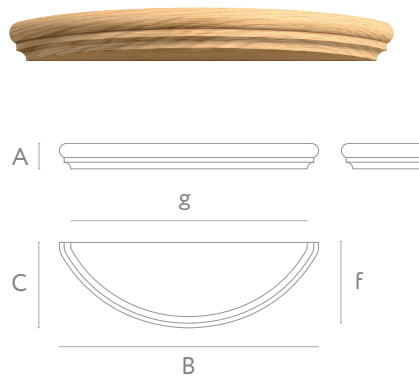

A	B	C	f	g	
15	108	37	30	94	mm
15	118	40	33	104	mm
15	138	46	39	124	mm
15	148	49	42	134	mm
20	174	58	49	156	mm
20	204	67	58	186	mm
25	250	83	71	227	mm

Капитель
KL-059



База
BS-006



Пилястра
PLM-020



База
BS-005



art. BS-005

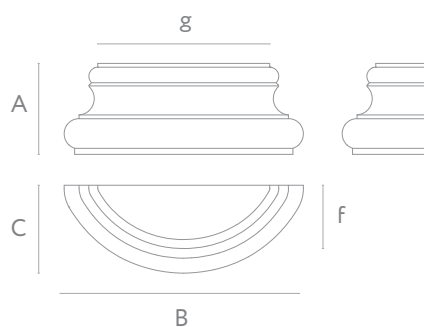

A	B	C	e	f	
600	90	28	40	40	mm
580	100	31	40	40	mm
1400	90	28	40	40	mm
2130	90	28	40	40	mm
1380	100	31	40	40	mm
2110	100	31	40	40	mm
1800	120	37	40	40	mm
2080	120	37	40	40	mm
2050	130	40	40	40	mm
2000	150	46	40	40	mm
2350	150	46	40	40	mm
2280	180	55	40	40	mm
2180	220	68	40	40	mm

A	B	C	f	g	
50	132	48	30	95	mm
55	146	54	33	105	mm
65	174	64	40	125	mm
70	188	69	43	135	mm
80	217	80	49	156	mm
100	263	97	60	189	mm
120	320	118	73	230	mm

Капитель
KL-003



База
BS-006



Пилястра
PLM-020



База
BS-005



art. DD-002L

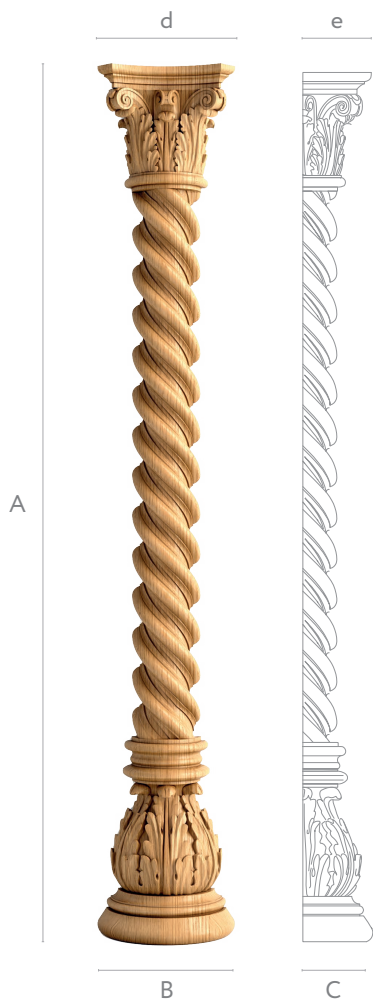

A	B	C	d	e	
1095	177	88	172	86	mm

art. DD-002R

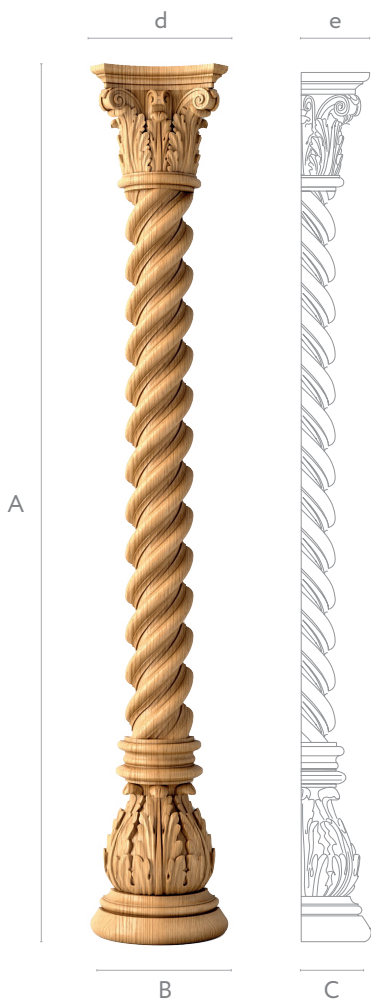

A	B	C	d	e	
1095	177	88	172	86	mm

art. DD-001

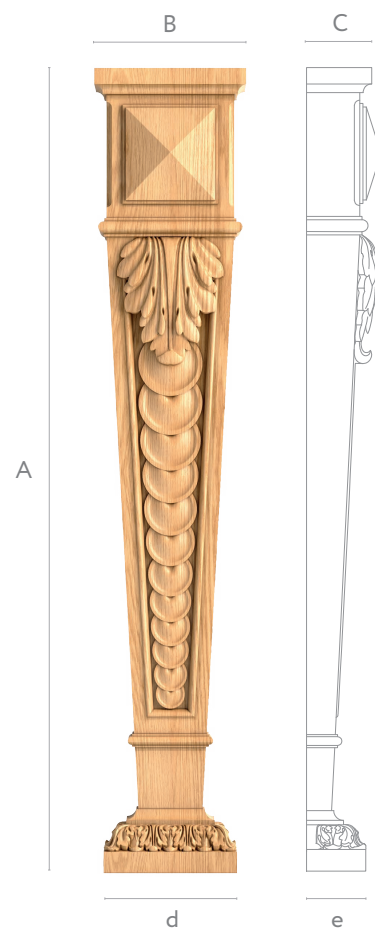

A	B	C	d	e	
740	140	69	123	54	mm



art. DD-007

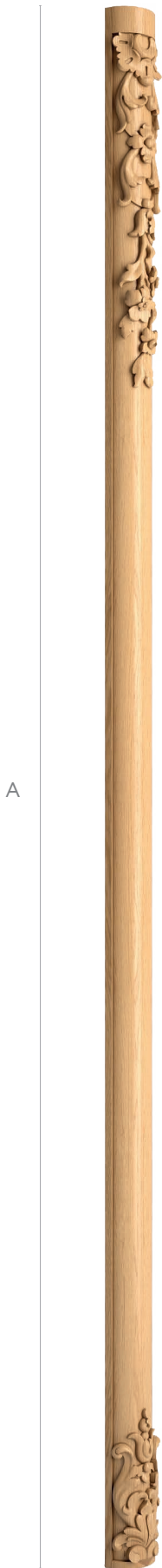

A	B	e	
1750	65	50	mm



art. DD-008



A	B	e	
650	63	50	mm
790	65	50	mm

art. DD-009

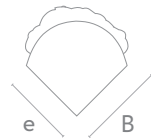

A	B	e	
460	65	50	mm



Ценителям мастерства

Оформить заказ вы можете на сайте или по телефону:

8 (800) 555-46-75



stavros.ru