

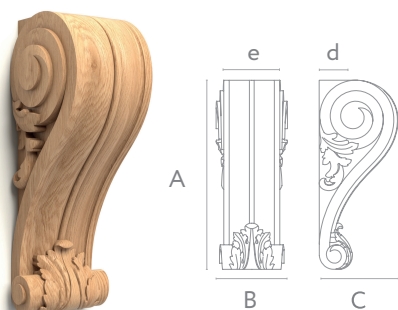

КРОНШТЕЙНЫ



Stavros[®]
Ценителям мастерства

art. KR-013

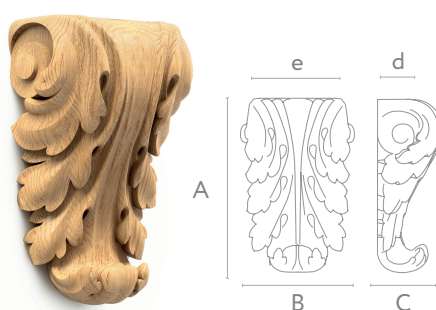

A	B	C	d	e	
131	50	55	27	39	mm
183	70	77	37	55	mm
235	90	99	48	71	mm
287	110	121	58	87	mm
345	132	145	70	104	mm
471	180	198	95	142	mm

art. KR-009.1



A	B	C	d	e	
87	55	32	17	37	mm
103	65	38	20	44	mm
119	75	44	23	50	mm
135	85	50	26	57	mm
151	95	55	29	64	mm
183	115	67	35	77	mm

art. KR-003

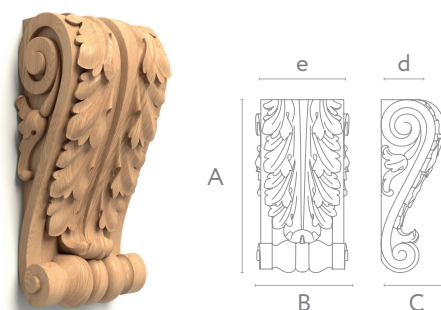

A	B	C	d	e	
99	50	34	23	47	mm
119	60	41	27	57	mm
139	70	48	32	66	mm
158	80	54	37	76	mm
179	90	61	42	85	mm
199	100	68	46	95	mm
238	120	82	56	114	mm

art. KR-002.01

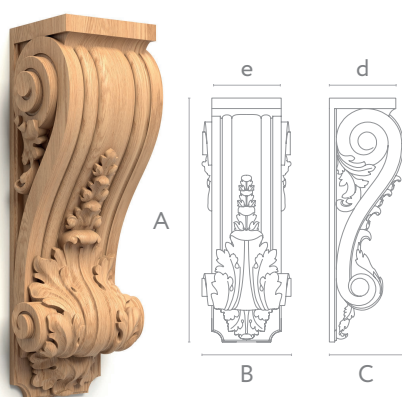

A	B	C	d	e	
191	70	58	52	55	mm
246	95	75	67	70	mm
301	116	91	82	86	mm
350	135	106	95	100	mm
410	157	124	111	117	mm

art. KR-014

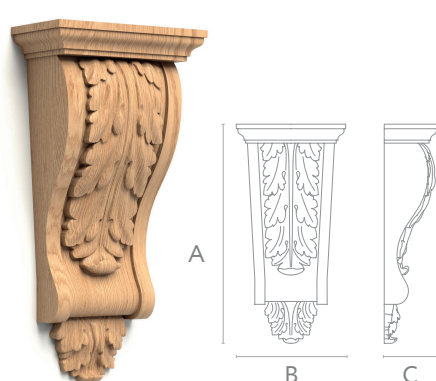

A	B	C	
150	75	37	mm
180	90	44	mm
210	105	52	mm
240	120	59	mm

art. KR-012

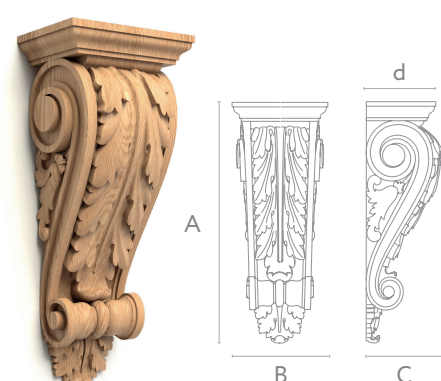

A	B	C	d	
198	80	63	57	mm
248	100	79	72	mm
298	120	94	86	mm
350	141	111	101	mm

art. KR-020

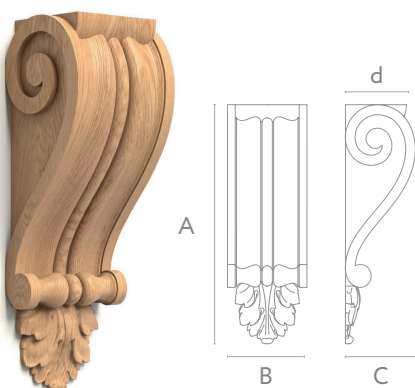

A	B	C	d	
149	50	44	39	mm
178	60	53	46	mm
223	75	66	58	mm
268	90	79	70	mm
297	100	88	77	mm

art. KR-033

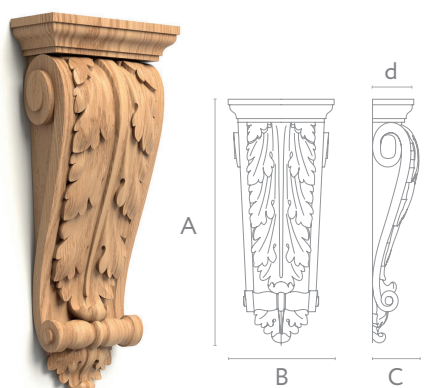

A	B	C	d	
157	70	31	29	mm
203	90	41	38	mm
236	105	47	44	mm
270	120	54	50	mm
315	140	63	58	mm

art. KR-004

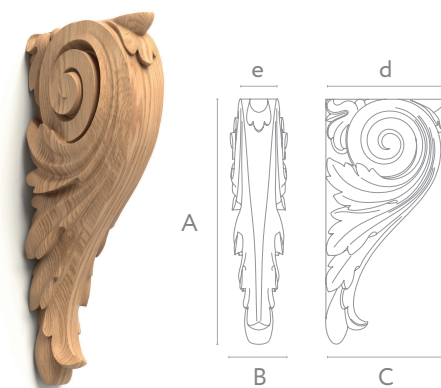

A	B	C	d	e	
150	35	73	71	24	mm
180	42	87	85	29	mm
236	55	114	111	38	mm

art. KR-019

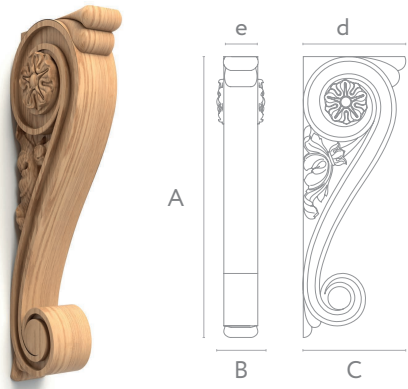

A	B	C	d	e	
180	31	66	65	22	mm
220	38	81	79	27	mm
260	45	95	94	32	mm
290	50	106	105	35	mm

art. KR-016

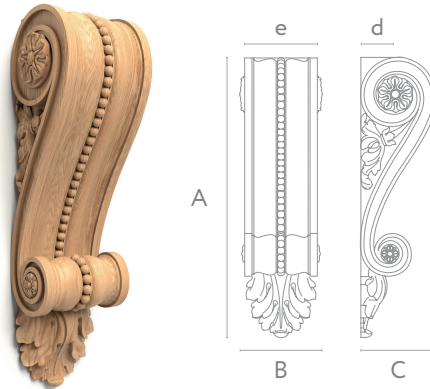

A	B	C	d	e	
271	80	74	36	71	mm
337	100	92	45	88	mm
407	120	110	55	106	mm

art. KR-008

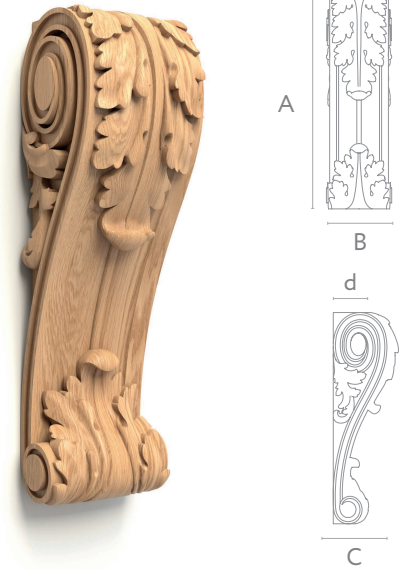

A	B	C	d	e	
161	50	50	26	45	mm
194	60	60	31	54	mm
258	80	80	42	72	mm
291	90	90	47	81	mm
323	100	100	52	90	mm
388	120	120	62	108	mm
452	140	140	72	126	mm
517	160	160	82	144	mm
581	180	180	93	162	mm

art. KR-005

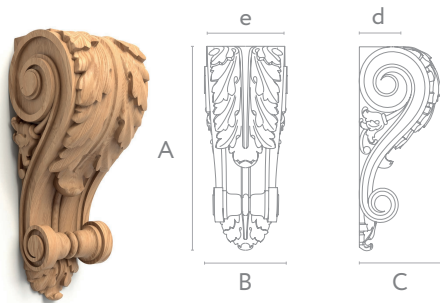

A	B	C	d	e	
100	41	40	22	38	mm
120	49	48	25	46	mm
150	61	60	33	58	mm
180	74	73	40	69	mm
215	88	87	46	83	mm
260	106	105	56	100	mm
300	123	121	65	115	mm
327	134	132	70	126	mm

art. KR-022

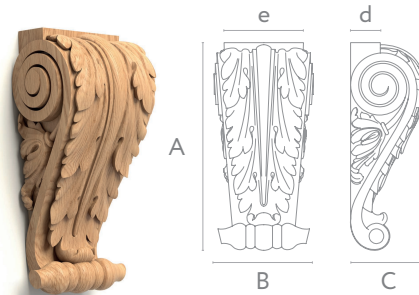

A	B	C	d	e	
104	50	38	15	40	mm
125	60	45	18	48	mm
152	73	55	22	59	mm
167	80	60	24	65	mm
208	100	75	30	81	mm

art. KR-018

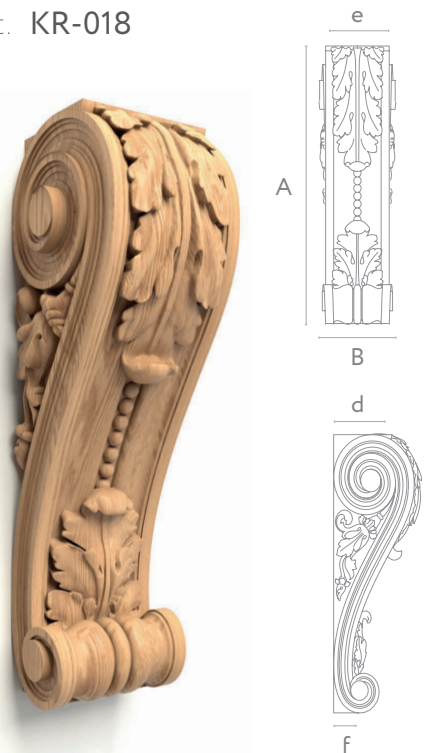

A	B	C	d	e	f	
259	80	92	61	66	27	mm
324	100	114	76	83	34	mm
373	115	131	87	95	39	mm
431	133	152	101	110	45	mm
518	160	183	122	132	54	mm
648	200	229	152	165	68	mm

art. KR-010

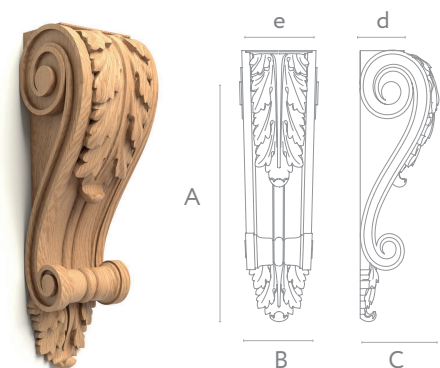

A	B	C	d	e	
180	57	57	32	54	mm
208	67	67	38	64	mm
243	77	77	43	73	mm
275	87	87	49	83	mm
338	107	107	60	102	mm
433	137	137	77	131	mm

art. KR-021

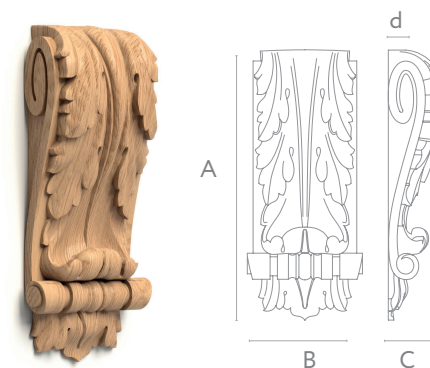

A	B	C	d		
99	40	22	7		mm
124	50	27	8		mm
149	60	33	10		mm
174	70	39	12		mm
199	80	44	13		mm
248	100	55	17		mm

art. KR-015

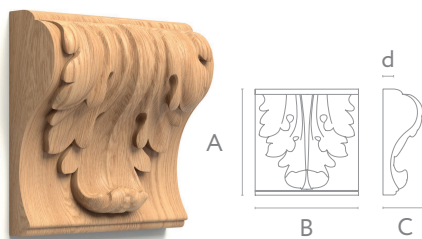

A	B	C	d	
51	50	19	5	mm
62	60	23	6	mm
72	70	27	7	mm
80	78	30	8	mm
103	100	40	10	mm
123	120	46	12	mm
144	140	54	14	mm

art. KR-048

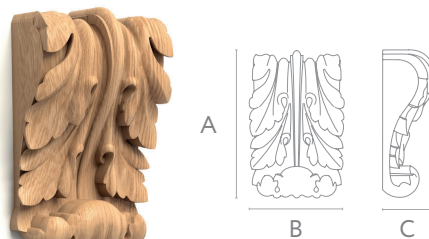

A	B	C	
93	60	34	mm
108	70	39	mm
130	84	47	mm
155	100	56	mm
186	120	67	mm
232	150	84	mm

art. KR-036

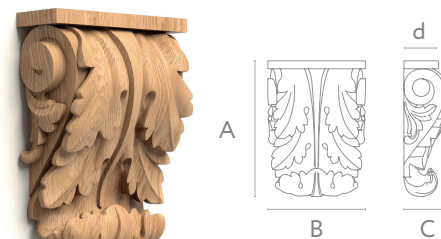

A	B	C	d	
83	60	29	22	mm
97	70	34	26	mm
111	80	39	29	mm
133	96	47	35	mm
166	120	59	44	mm

art. KR-028

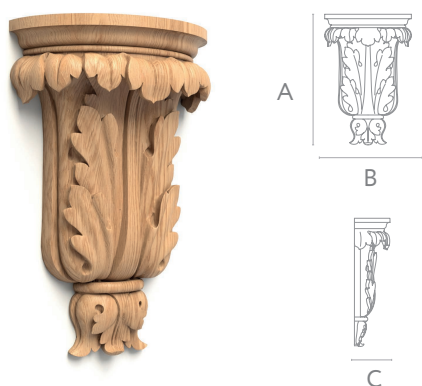

A	B	C	
150	100	42	mm
195	130	54	mm
248	165	69	mm
301	200	84	mm

art. KR-047

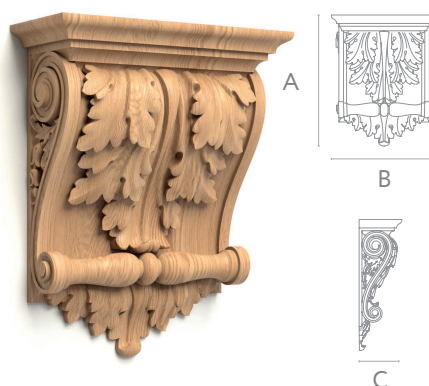

A	B	C	
186	150	61	mm
224	180	73	mm
249	200	81	mm
286	230	93	mm
323	260	105	mm

art. KR-057

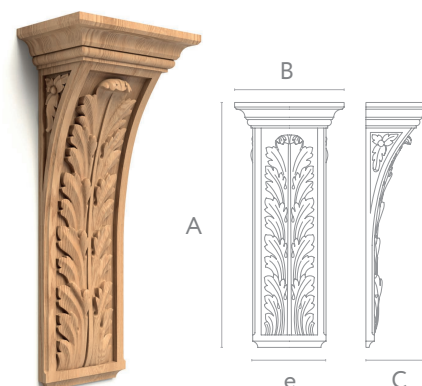

A	B	C	e	
268	120	73	80	mm
335	149	91	100	mm
435	194	118	130	mm

art. KR-032



A	B	C	d	e	
162	60	160	138	39	mm
203	75	200	172	48	mm
255	94	250	215	61	mm
305	113	300	258	73	mm
353	130	346	298	84	mm

art. KR-054



A	B	C	d	e	
115	69	160	130	55	mm
179	107	250	203	86	mm
237	141	330	268	113	mm
318	190	443	360	152	mm

art. KR-039

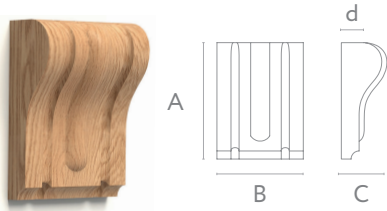

A	B	C	d	
58	43	23	11	mm
81	60	32	15	mm
108	80	43	20	mm
135	100	53	26	mm

art. KR-038

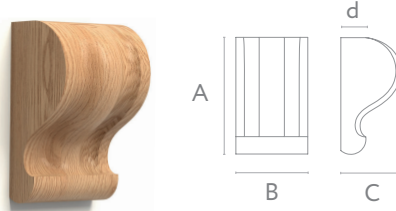

A	B	C	d	
68	42	35	14	mm
81	50	42	17	mm
113	70	58	23	mm
146	90	75	30	mm

art. KR-017L



art. KR-017R

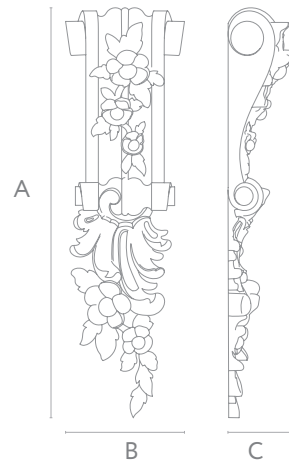

A	B	C	
273	80	45	mm
341	100	56	mm
453	133	74	mm
511	150	84	mm

art. KR-037

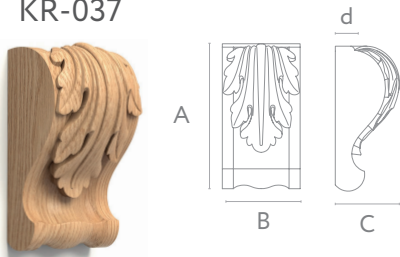

A	B	C	d	
74	40	33	14	mm
93	50	41	18	mm
111	60	50	21	mm
130	70	58	25	mm
148	80	66	28	mm

art. KR-006

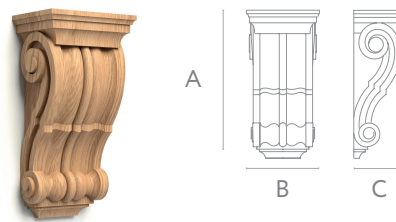

A	B	C	
121	60	43	mm
141	70	50	mm
160	80	57	mm
220	109	78	mm
262	130	93	mm

art. KR-041

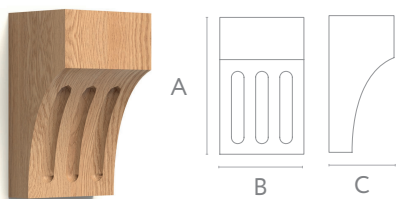

A	B	C	
65	40	31	mm
81	50	39	mm
114	70	54	mm
146	90	70	mm

art. KR-042

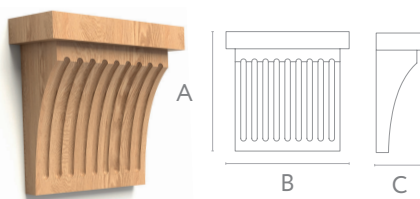

A	B	C	
65	67	27	mm
87	90	36	mm
107	110	44	mm
126	130	52	mm
155	160	64	mm

art. KR-043

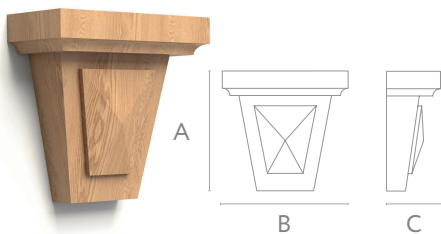

A	B	C	
76	80	34	mm
95	100	43	mm

art. KR-044

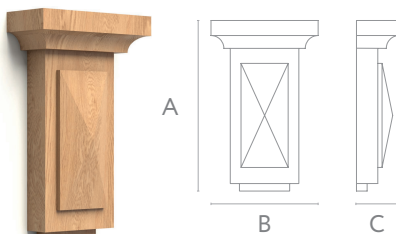

A	B	C	
80	50	20	mm
112	70	28	mm
128	80	32	mm

art. KR-045

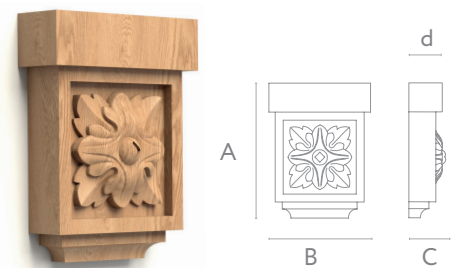

A	B	C	d	
62	47	17	15	mm
79	60	22	19	mm
92	70	25	22	mm
112	85	31	27	mm
132	100	36	32	mm
158	120	43	38	mm
185	140	51	45	mm

art. KR-030

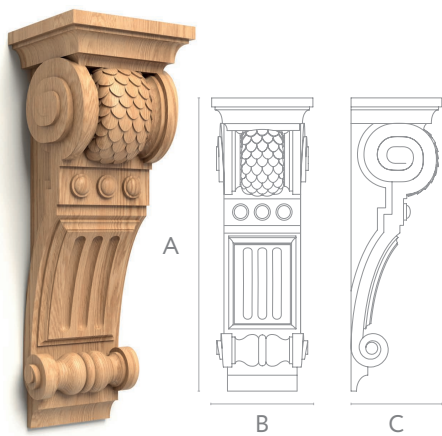

A	B	C	
230	80	72	mm

art. KR-007

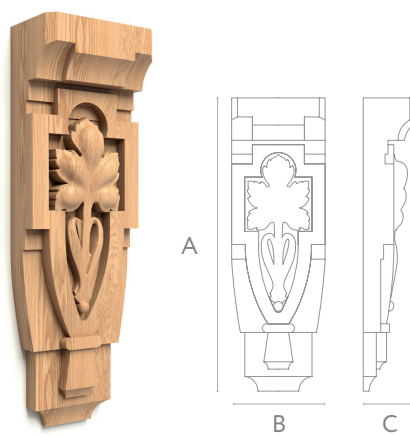

A	B	C	
200	64	36	mm
250	80	45	mm

art. KR-029

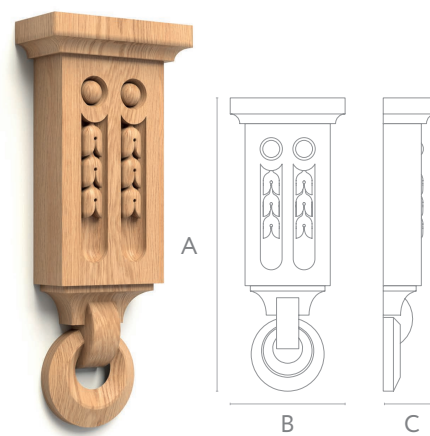

A	B	C	
176	70	33	mm
214	85	40	mm
252	100	47	mm
302	120	56	mm

art. KR-026

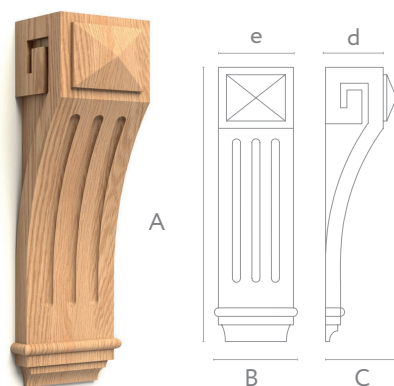

A	B	C	d	e	
156	50	43	35	45	mm
210	67	58	47	61	mm
250	80	69	56	72	mm
312	100	86	70	90	mm
374	120	103	84	108	mm

art. KR-025

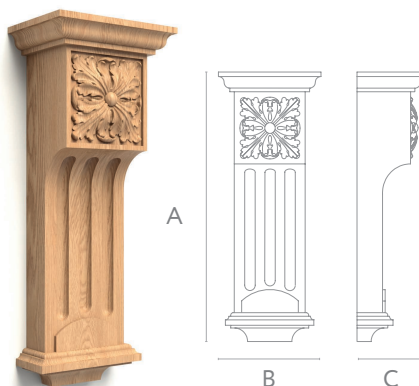

A	B	C	
206	80	55	mm
258	100	68	mm
299	116	79	mm
361	140	95	mm

art. KR-024

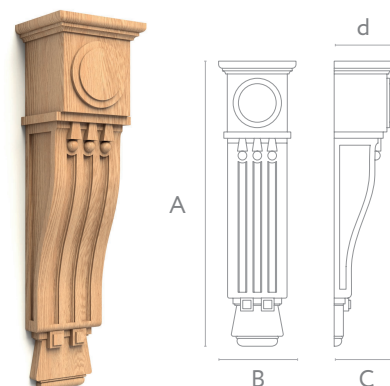

A	B	C	d	
217	60	50	48	mm
263	73	61	58	mm
300	83	69	66	mm
434	120	100	96	mm

art. KR-027

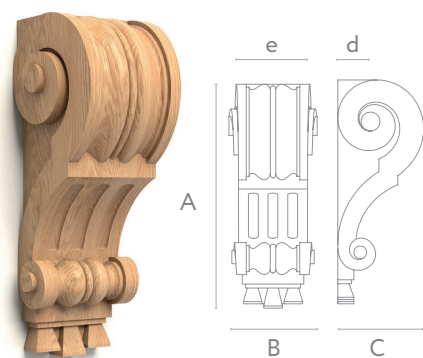

A	B	C	d	e	
152	60	58	27	47	mm
177	70	68	32	55	mm
202	80	77	36	63	mm
230	91	88	41	72	mm
278	110	106	50	87	mm

art. KR-001

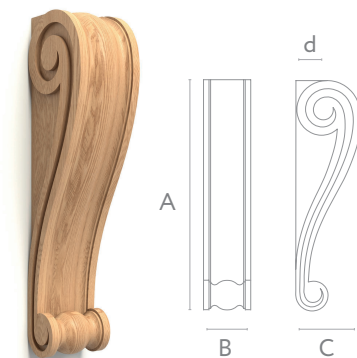

A	B	C	d	
140	29	39	22	mm
165	34	46	27	mm
193	40	54	31	mm
276	56	77	44	mm

art. KR-049

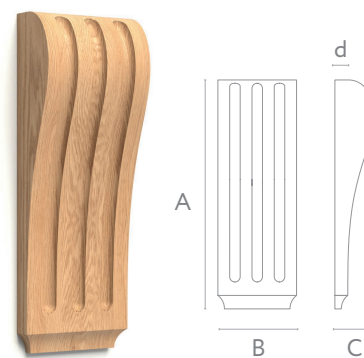

A	B	C	d	
113	40	21	7	mm
142	50	26	8	mm
170	60	31	10	mm
198	70	36	12	mm
227	80	41	13	mm
283	100	52	17	mm

art. KR-051

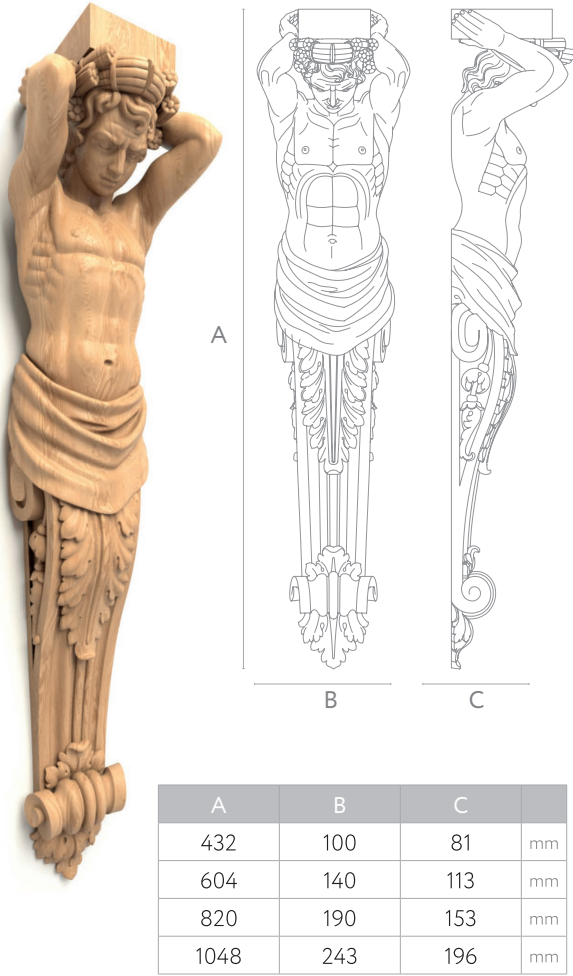

art. KR-046.1R

art. KR-046.1L

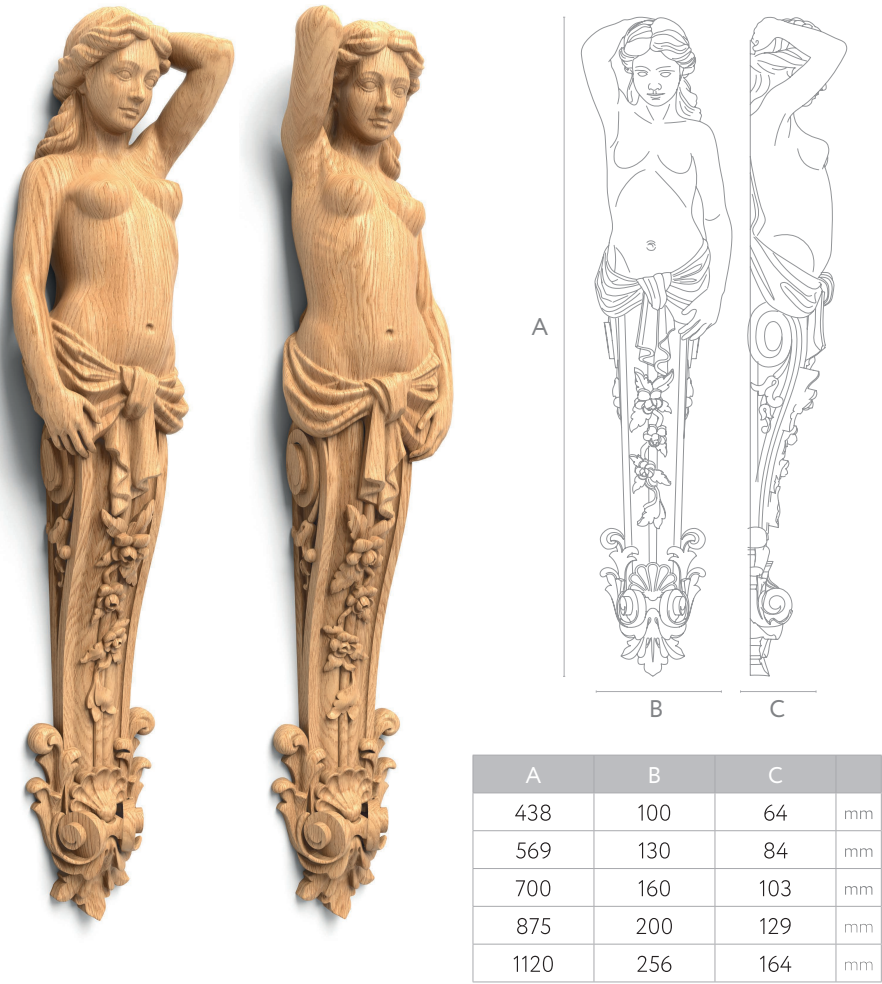

art. KR-031

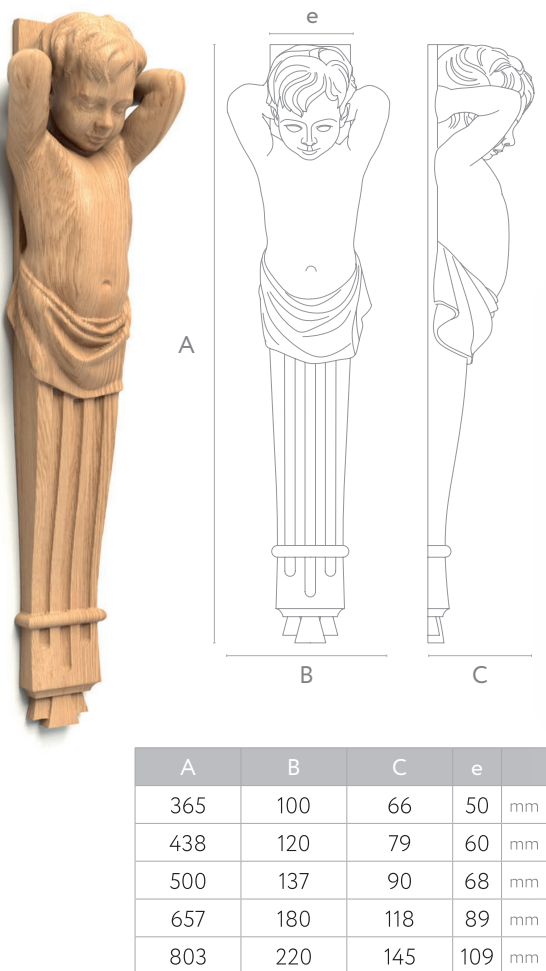

art. KR-068L

art. KR-068R

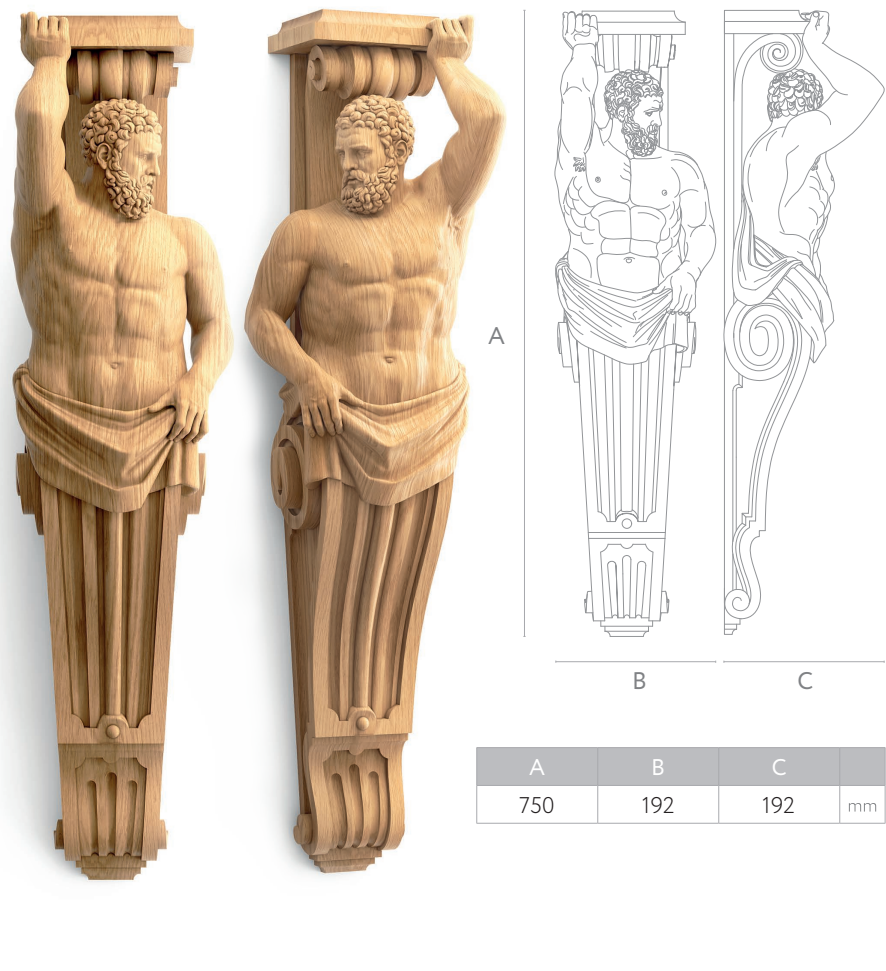

art. KR-050L

art. KR-050R

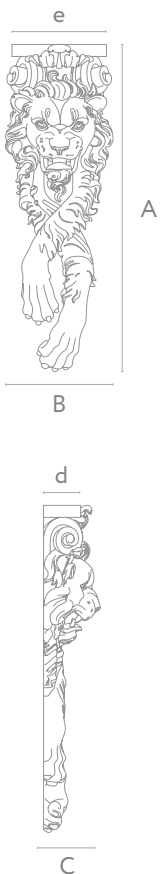

A	B	C	d	e	
273	90	48	31	79	mm
349	115	61	40	101	mm
434	143	76	49	123	mm
546	180	96	62	159	mm
638	210	112	72	185	mm
868	286	152	98	252	mm

art. KR-034



A	B	C	
237	90	94	mm
290	110	115	mm
369	140	146	mm
448	170	177	mm

art. KR-023

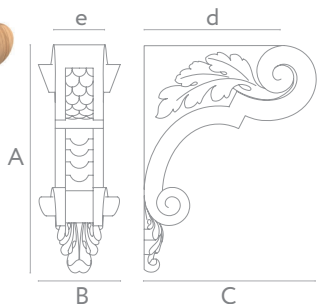

A	B	C	d	e	
150	55	114	93	34	mm
190	69	144	118	43	mm
225	82	171	140	51	mm
260	94	197	162	59	mm

art. KR-069

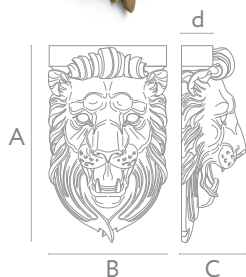

A	B	C	d	
158	95	52	25	mm
235	142	77	37	mm

art. KR-056

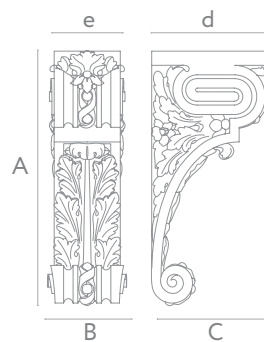

A	B	C	d	e	
231	71	108	103	60	mm
308	95	144	137	80	mm
385	119	180	171	100	mm

art. KR-062

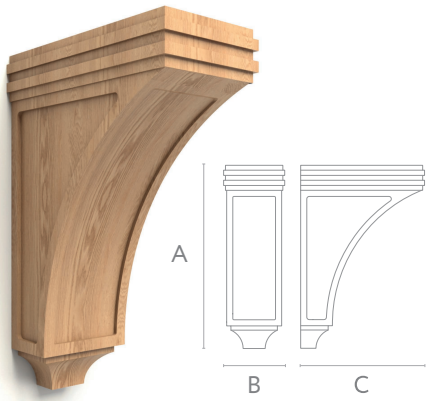

A	B	C	
300	100	203	mm

art. KR-060

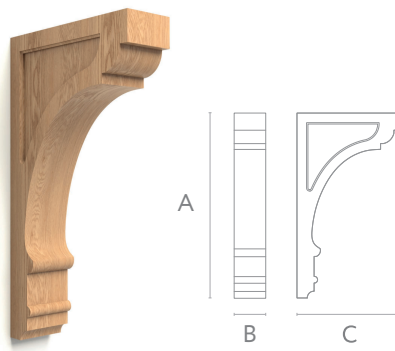

A	B	C	
270	46	150	mm

art. KR-063

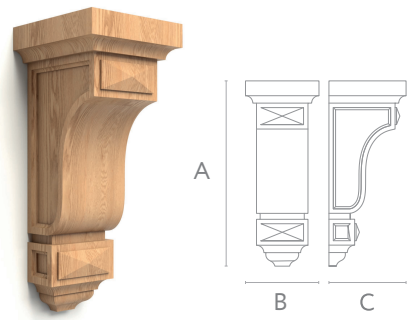

A	B	C	
250	100	105	mm

art. KR-064

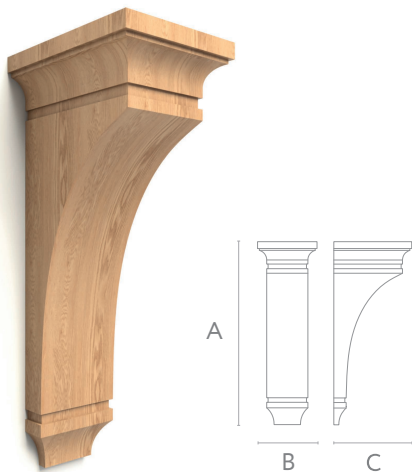

A	B	C	
400	130	170	mm

art. KR-066

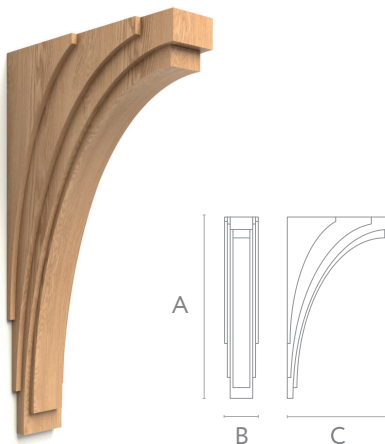

A	B	C	
320	60	180	mm

art. KR-067

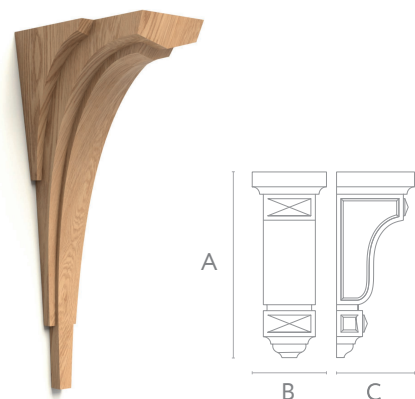

A	B	C	
212	63	100	mm

art. KR-053

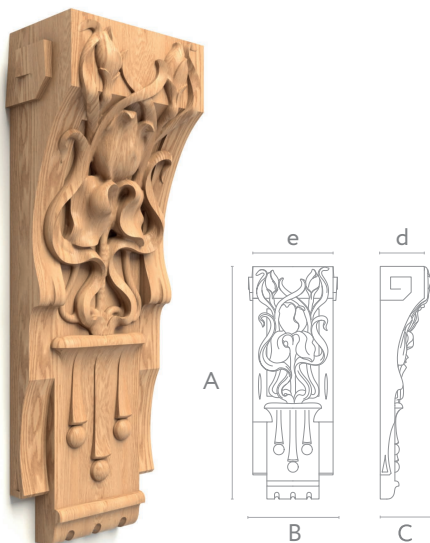

A	B	C	d	e	
162	62	36	31	56	mm
234	89	52	44	81	mm
288	110	64	55	99	mm
360	138	80	69	124	mm
450	172	99	86	155	mm

art. KR.VRS-013

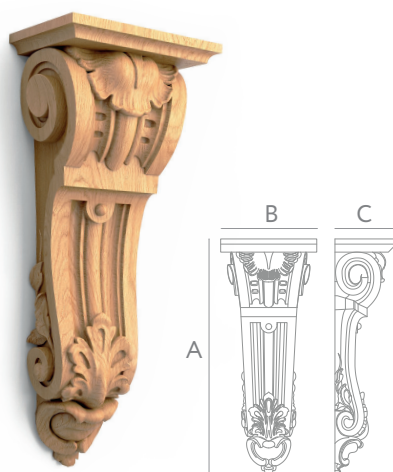

A	B	C	
250	100	61	mm

art. KR-011

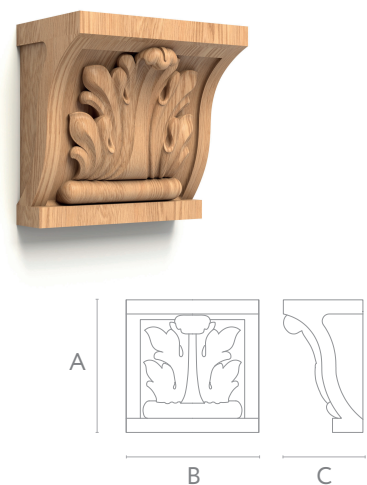

A	B	C	
75	75	45	mm
90	90	54	mm
110	110	66	mm
150	150	90	mm





Ценителям мастерства

Оформить заказ вы можете на сайте или по телефону:

8 (800) 555-46-75



stavros.ru