

# СОВРЕМЕННАЯ КОЛЛЕКЦИЯ

## Ножки



Уже 20 лет наша фабрика производит ножки из ценных пород древесины для различных видов мебели. В ассортименте более 100 моделей, отличающихся актуальным дизайном и совершенными пропорциями.

- Нарядные резные и лаконичные точеные ножки для столов, стульев, банкетов и табуретов.
- Высокие опоры для барных стоек.
- Невысокие ножки для диванов, кроватей, пуфов, кресел, шкафов, комодов, тумб.

Каждая модель создана, чтобы подчеркнуть индивидуальность мебели и интерьера в целом.

Широкий размерный ряд позволяет подбирать ножки из одной дизайнерской линейки для различных предметов мебели и создавать комплекты в едином стиле.

Для удобства монтажа, мы можем оснастить ножки специальной системой крепления, которая позволит быстро и легко произвести установку, а также сэкономить время на самостоятельном подборе необходимой крепежной и соединительной фурнитуры.

Безупречное качество исполнения - наш приоритет.



- Производим опоры из массива бука и дуба с помощью современного оборудования.
- В каждом цехе работает автоматическая система поддержания влажностного и температурного режима.
- Не экономим на качестве: используем только технологически правильно высушенную древесину от ответственных российских поставщиков.
- При переклейке заготовок для будущих изделий используем клей KLEIBERIT 303.2 (Германия, качество склеивания - D3) и мощные прессы.
- Поддерживаем складскую программу на самые востребованные модели.
- Заказ от 1 шт. Быстрая доставка по всей России.

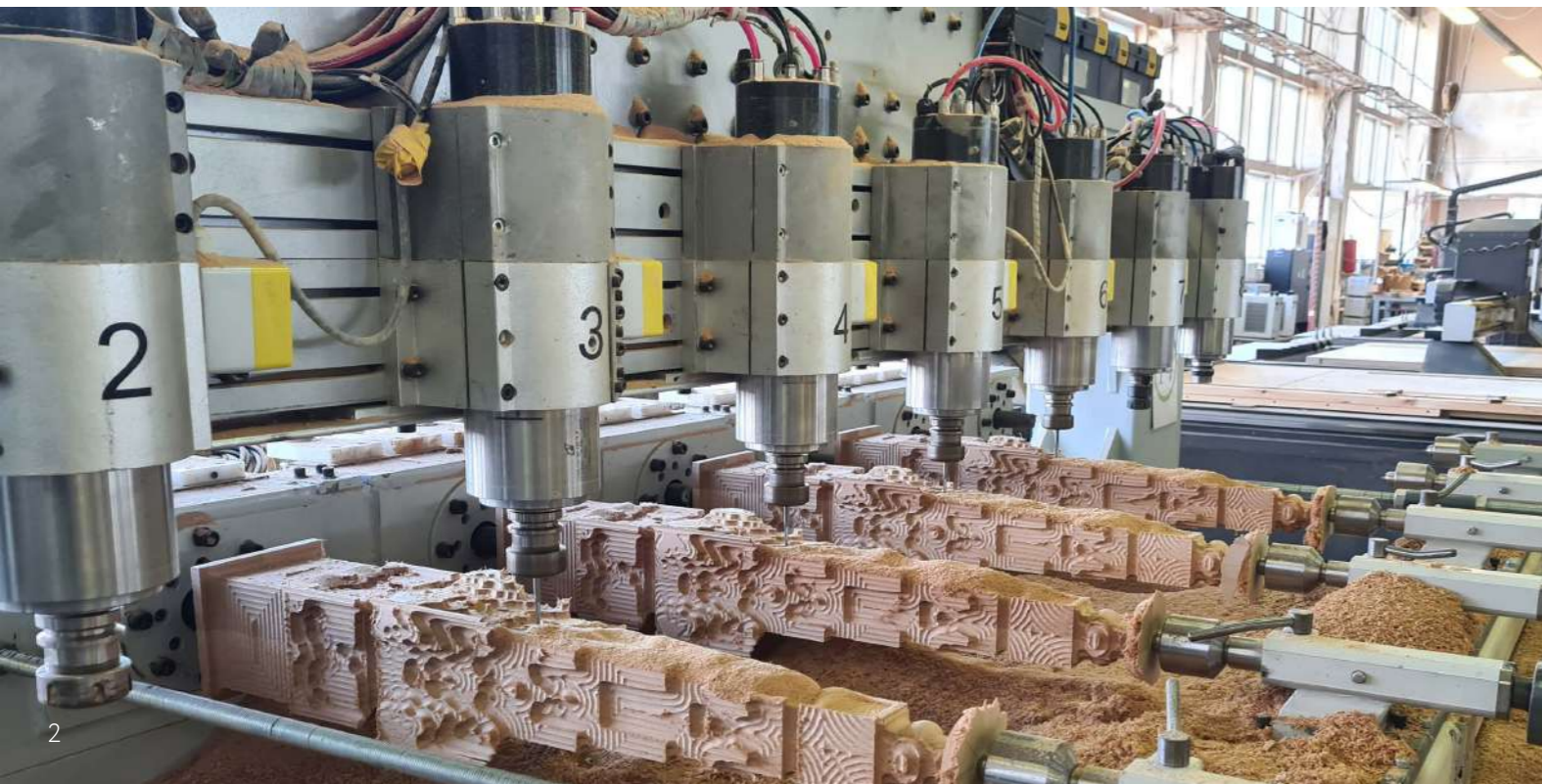



art. MN-126

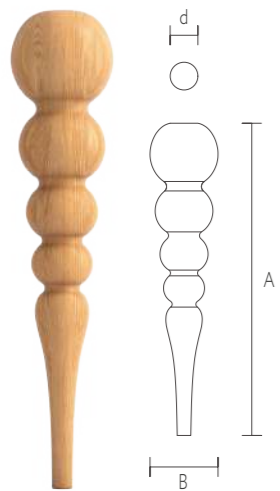

A	B	C	D	mm
720	157	157	64	mm

art. MN-127

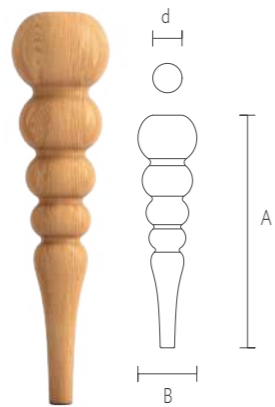

A	B	C	D	mm
390	99	99	49	mm

art. MN-085

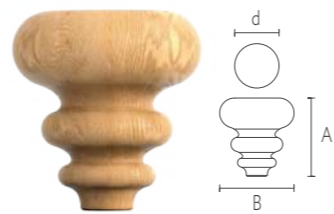

A	B	C	D	mm
120	114	114	68	mm

art. MN-124

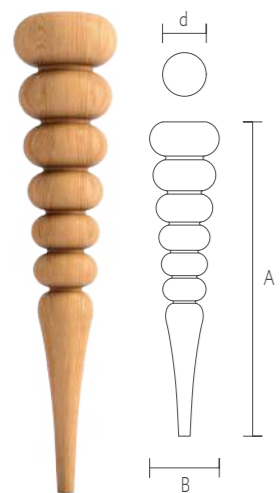

A	B	C	D	mm
720	160	160	100	mm

art. MN-095

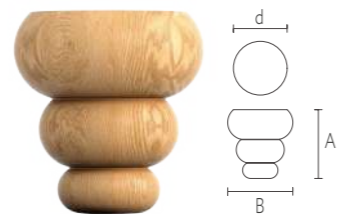

A	B	C	D	mm
95	90	90	74	mm

art. MN-097

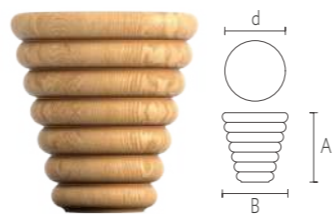

A	B	C	D	mm
95	90	90	83	mm



art. MN-145.1

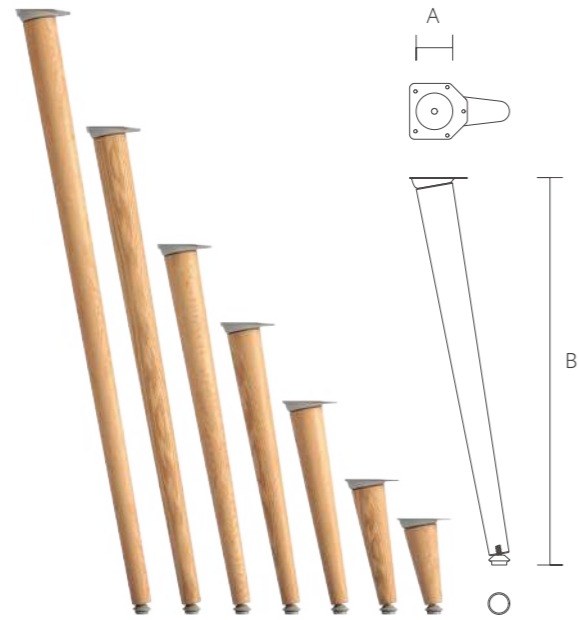

A	B	
252	44	mm
350	44	mm
449	44	mm
597	44	mm
744	44	mm

art. MN-145

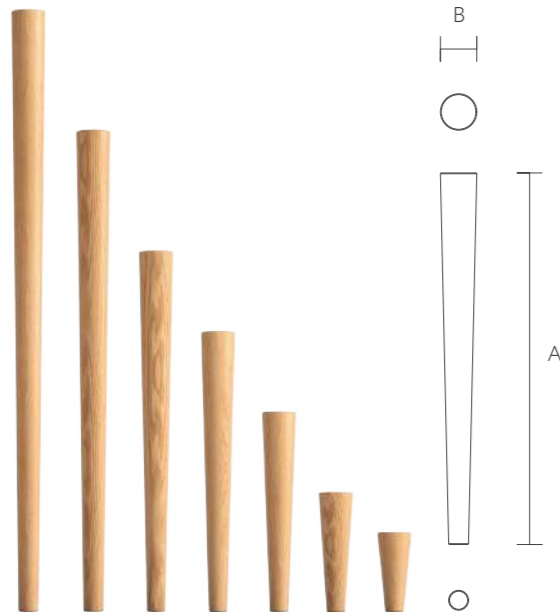

A	B	
100	44	mm
150	44	mm
200	44	mm
250	44	mm
300	44	mm
350	44	mm
400	44	mm
450	44	mm
500	44	mm
600	44	mm
650	44	mm
700	44	mm
750	44	mm

art. MN-145.2

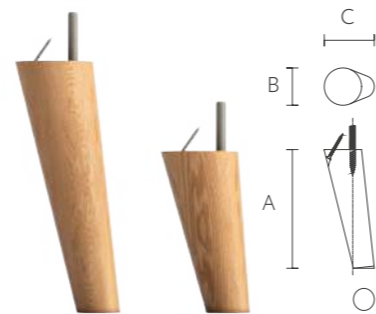

A	B	C	
90	44	50	mm
140	44	59	mm





art. MN-108



A	B	C	mm
720	84	84	mm

art. MN-110

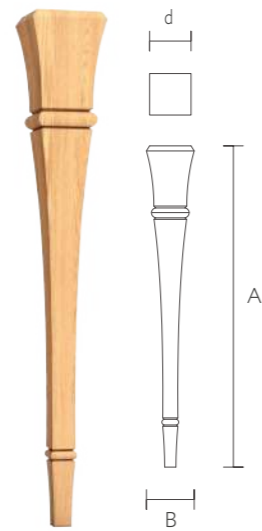

A	B	C	D	mm
720	107	107	93	mm

art. MN-109

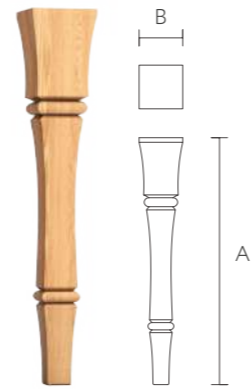

A	B	C	mm
390	69	69	mm

art. MN-137

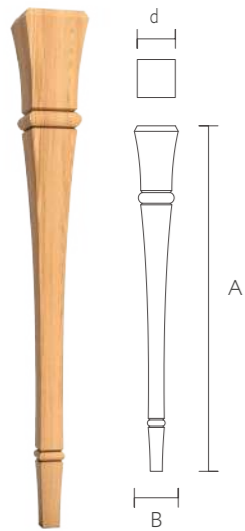

A	B	D	mm
1100	140	121	mm

art. MN-111



A	B	C	D	mm
390	82	82	68	mm

art. MN-133

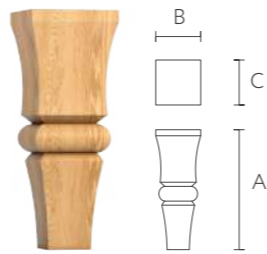

A	B	C	mm
160	60	60	mm



art. MN-114

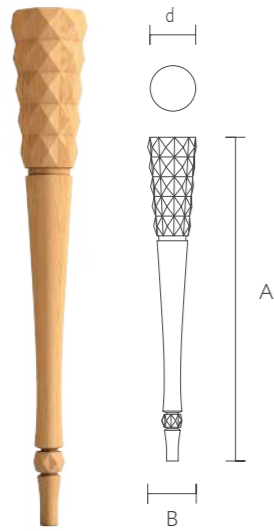

A	B	C	D	mm
720	107	107	101	

art. MN-115



A	B	C	D	mm
390	74	74	70	

art. MN-118

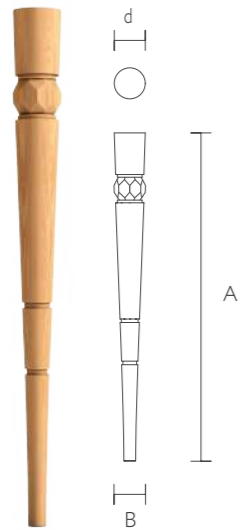

A	B	C	D	mm
720	69	69	68	

art. MN-119

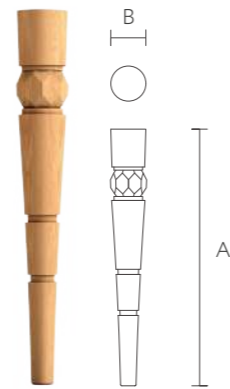

A	B	C	mm
390	53	53	



art. MN-120

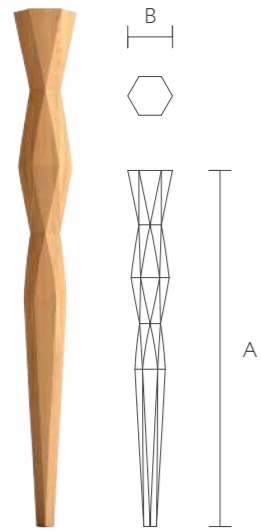

A	B	C	mm
720	91	91	mm

art. MN-121

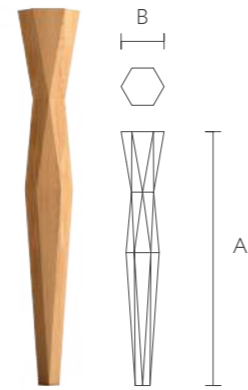

A	B	C	mm
390	66	66	mm

art. MN-101

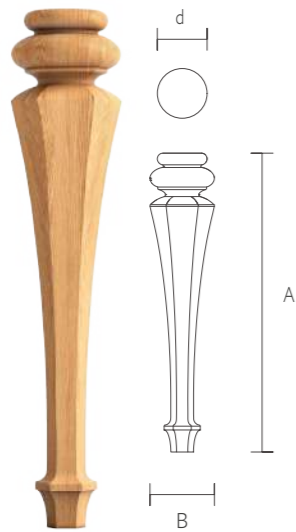

A	B	D	mm
390	84	65	mm

art. MN-134



A	B	D	mm
150	96	81	mm





art. MN-202.1

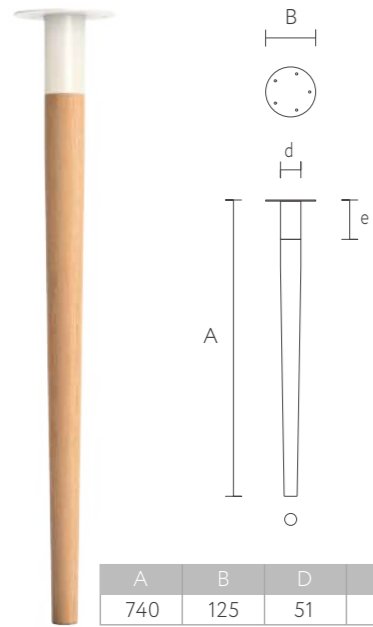

A	B	D	E	mm
740	125	51	98	mm

art. MN-202.2

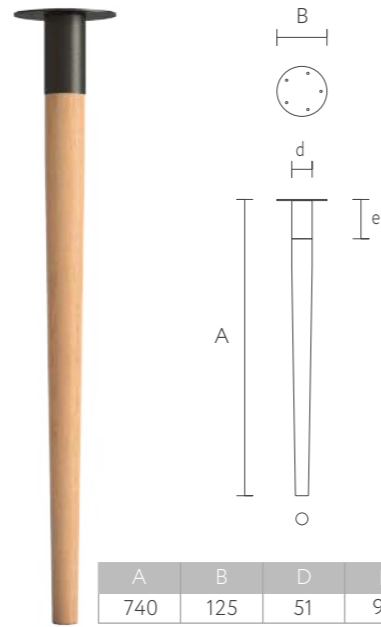

A	B	D	E	mm
740	125	51	98	mm

art. MN-195.1

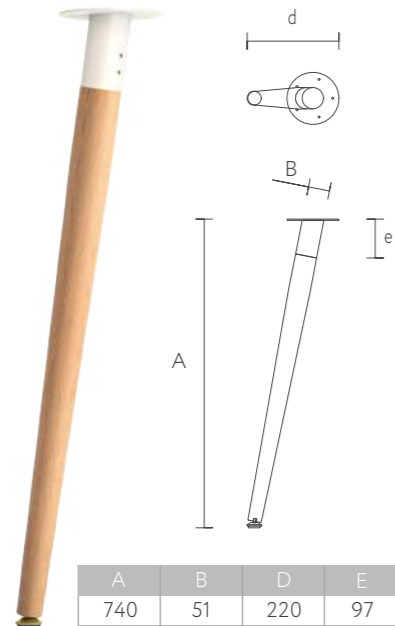

A	B	D	E	mm
740	51	220	97	mm

art. MN-195.2

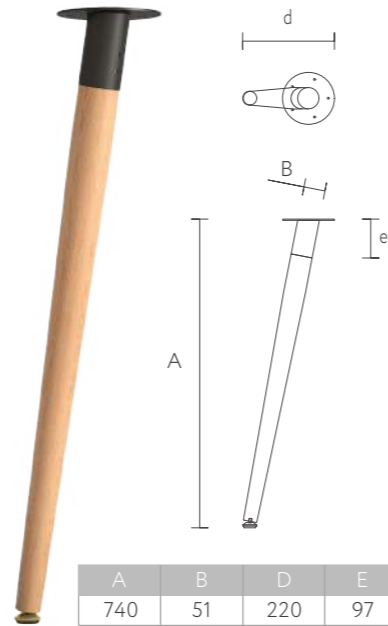

A	B	D	E	mm
740	51	220	97	mm





art. MN-148.1

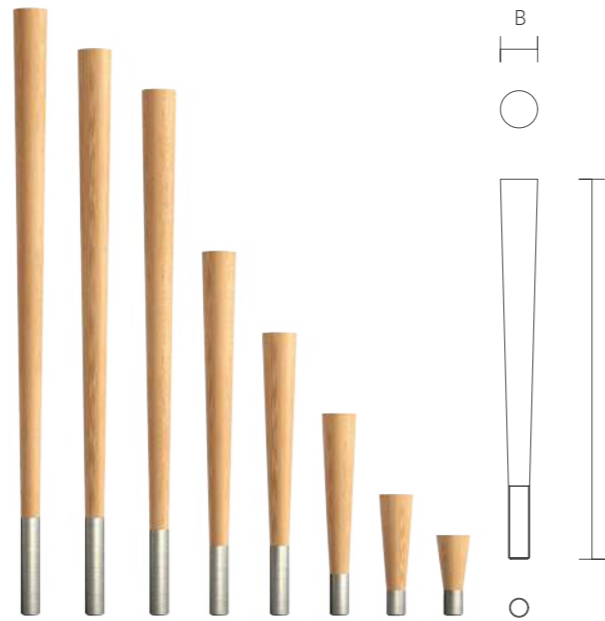

A	B	C	
100	44	25	mm
150	44	25	mm
250	44	25	mm
350	44	25	mm
450	44	25	mm
650	44	25	mm
700	44	25	mm
750	44	25	mm

art. MN-148

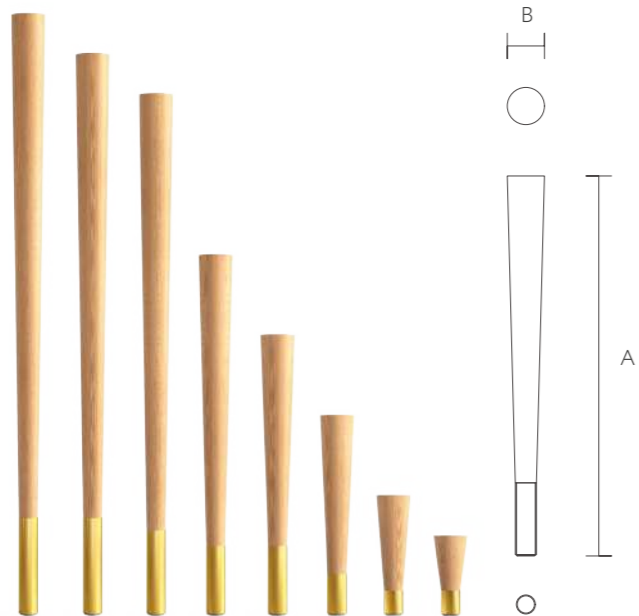

A	B	C	
100	44	25	mm
150	44	25	mm
250	44	25	mm
350	44	25	mm
450	44	25	mm
650	44	25	mm
700	44	25	mm
750	44	25	mm





art. MN-149.1

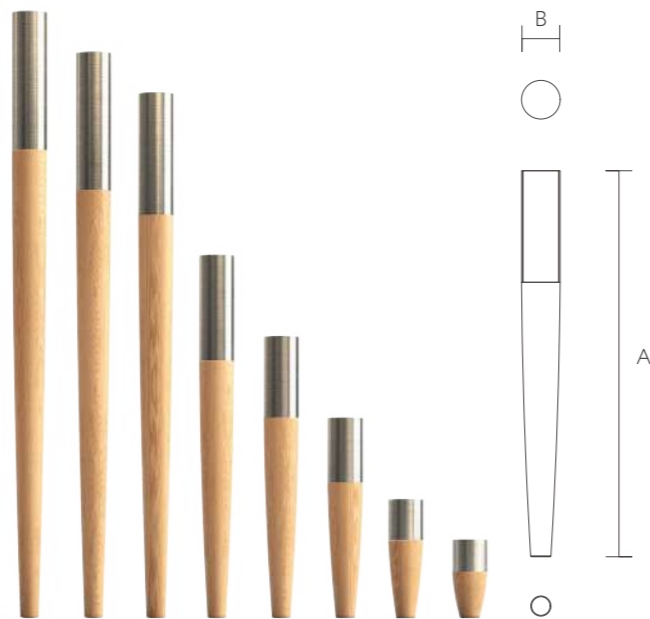

A	B	C	mm
100	44	24	mm
150	44	24	mm
250	44	24	mm
350	44	24	mm
450	44	24	mm
650	44	24	mm
700	44	24	mm
750	44	24	mm

art. MN-149

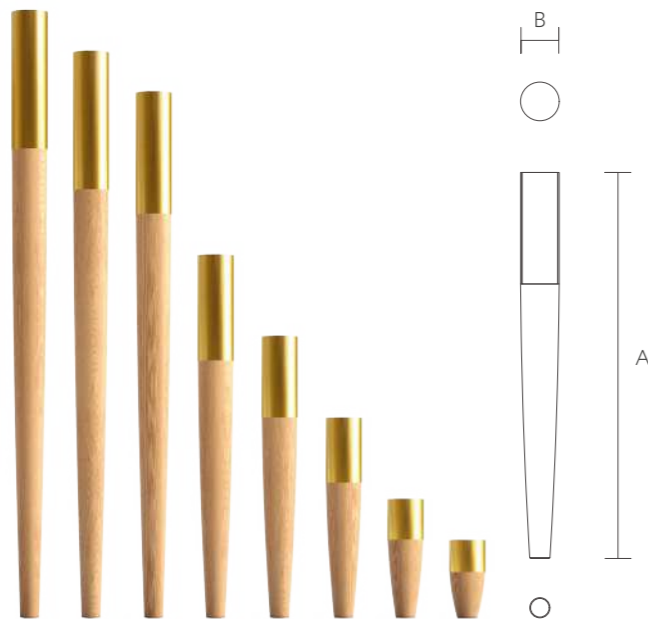

A	B	C	mm
100	44	24	mm
150	44	24	mm
250	44	24	mm
350	44	24	mm
450	44	24	mm
650	44	24	mm
700	44	24	mm
750	44	24	mm

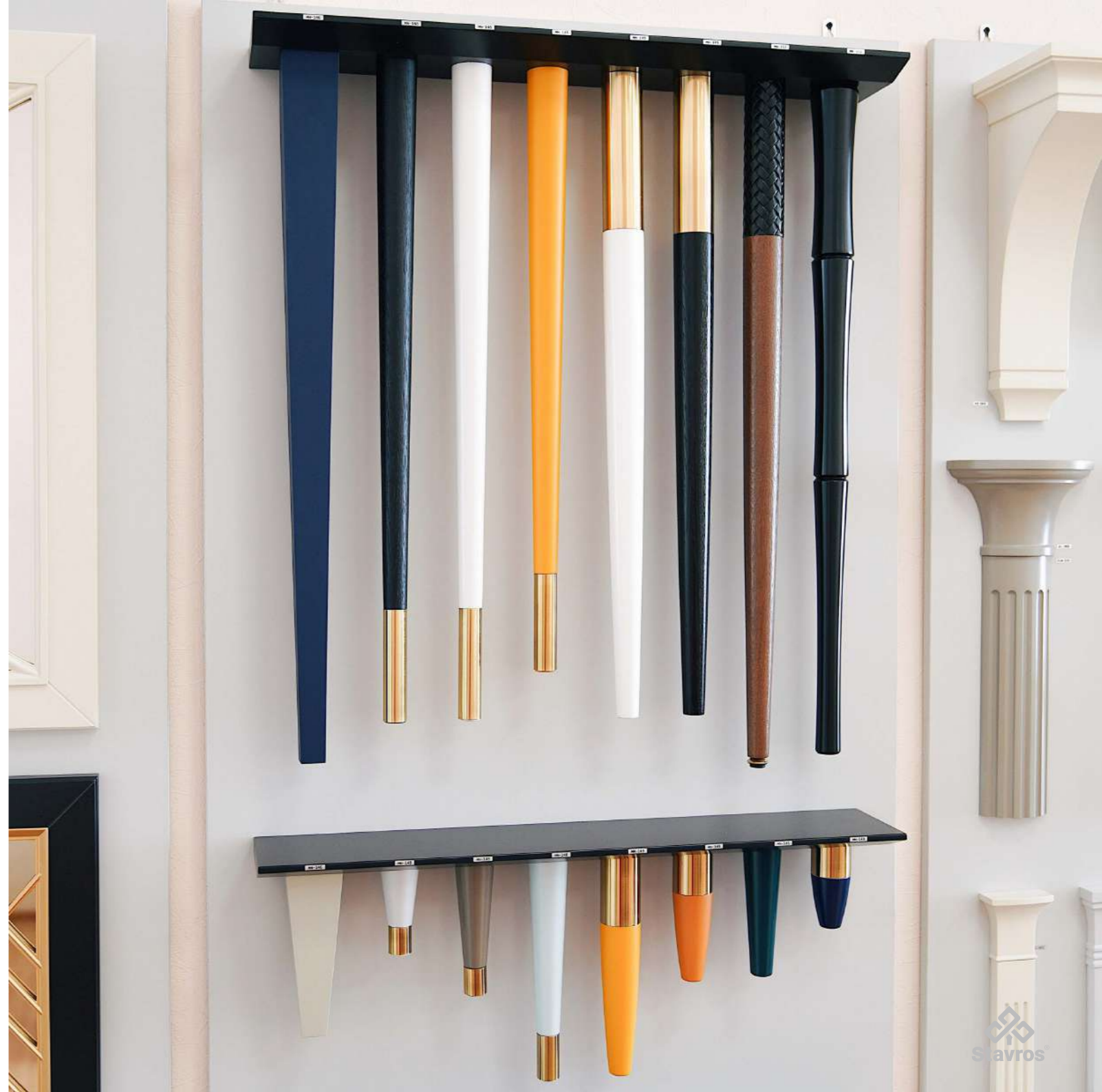



art. MN-081

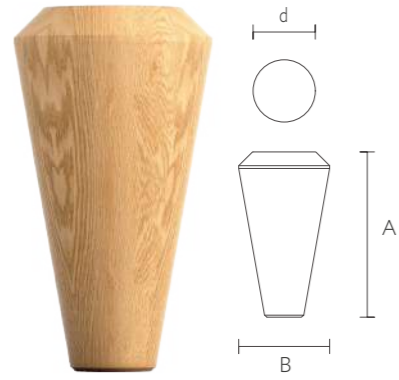

A	B	C	D	mm
120	66	66	45	

art. MN-094

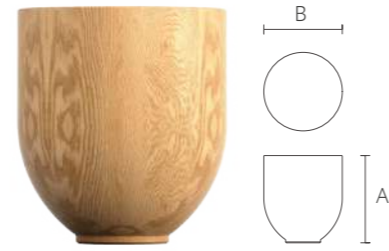

A	B	C	mm
100	90	90	

art. MN-089

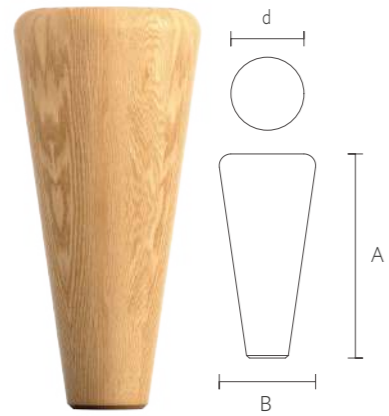

A	B	C	D	mm
140	66	66	50	

art. MN-088

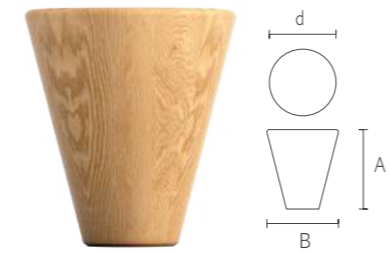

A	B	C	D	mm
100	90	90	84	



art. MN-186

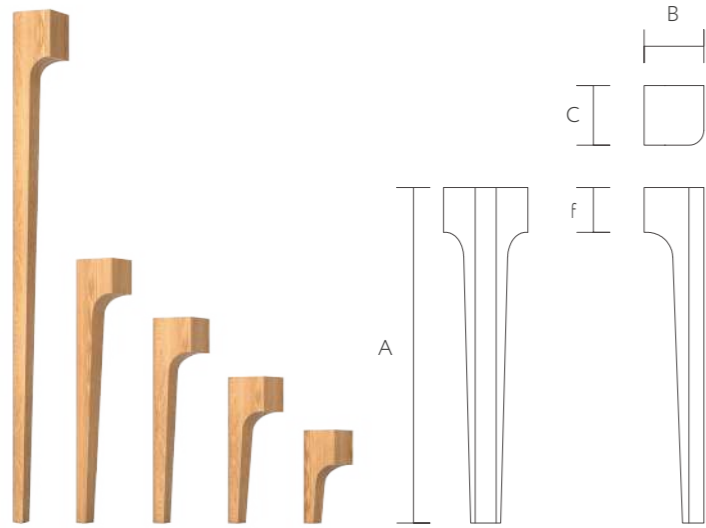

A	B	C	F	mm
160	70	70	60	mm
250	80	80	60	mm
350	80	80	60	mm
450	80	80	60	mm
740	80	80	80	mm

art. MN-187

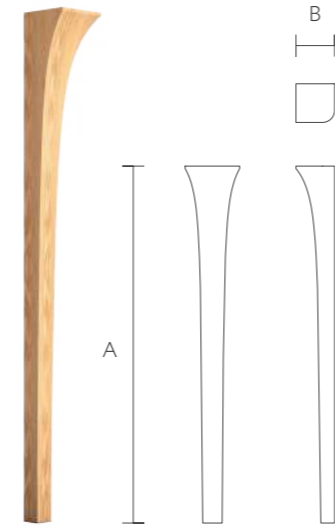

A	B	C	F	mm
740	80	80	80	mm

art. MN-146

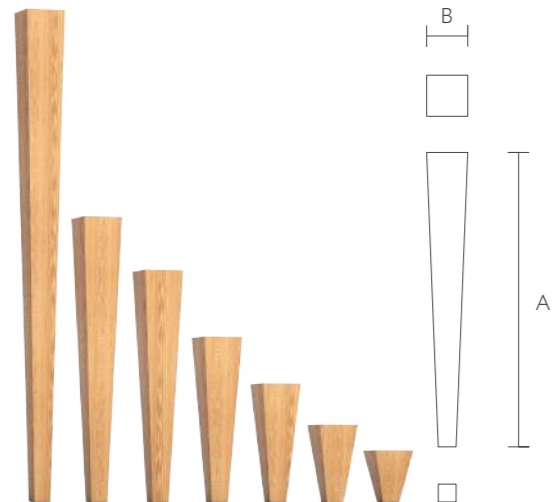

A	B	mm
80	60	mm
120	60	mm
180	60	mm
250	60	mm
350	60	mm
430	60	mm
740	60	mm

art. MN-192

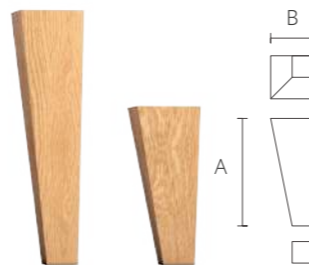

A	B	mm
150	60	mm
240	60	mm





art. MN-198

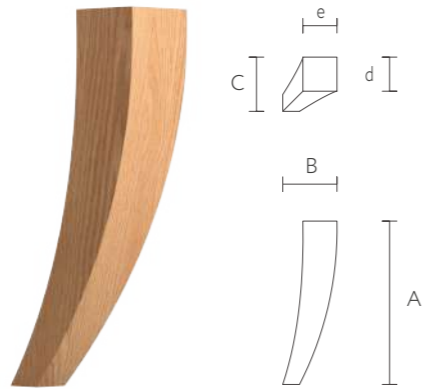

A	B	C	D	E	mm
240	80	80	50	50	mm



art. MN-196

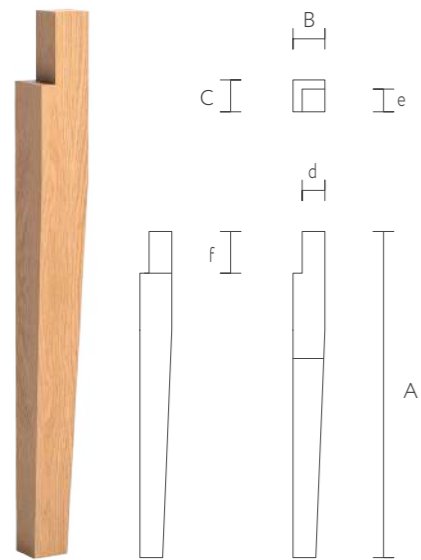

A	B	C	D	E	F	mm
430	42	42	30	30	55	mm

art. MN-197

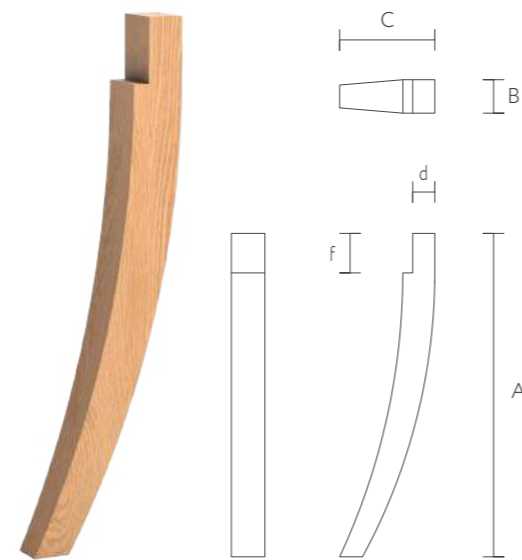

A	B	C	D	E	F	mm
430	44	126	29	29	55	mm



art. MN-098

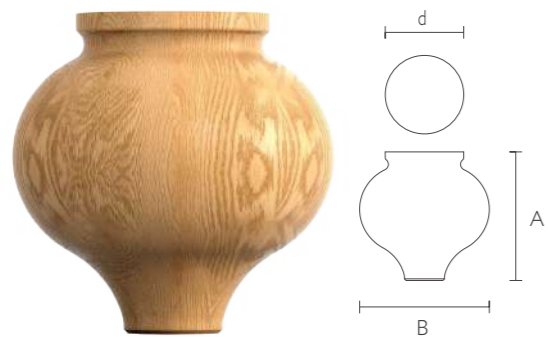

A	B	C	D	
113	114	114	69	mm
160	162	162	98	mm

art. MN-093

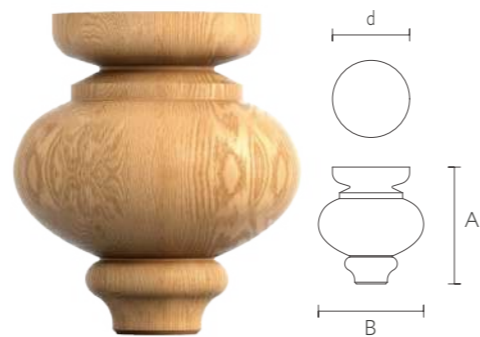

A	B	C	D	
100	90	90	66	mm

art. MN-024

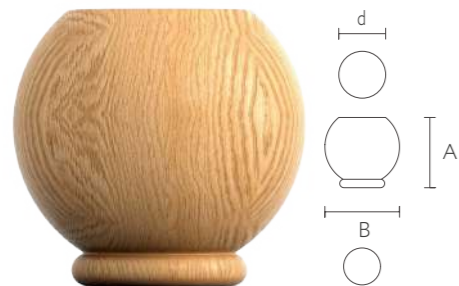

A	B	D	
60	64	40	mm
80	85	53	mm
100	106	66	mm

art. MN-023



A	B	D	
45	80	58	mm
60	107	77	mm
70	124	90	mm





art. MN-188

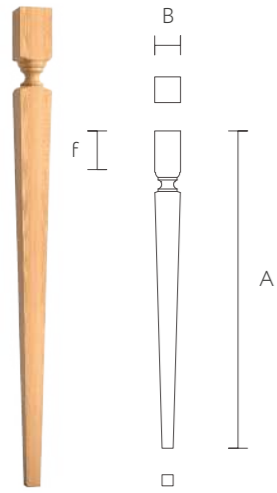

A	B	F	mm
740	60	90	mm
870	60	90	mm

art. MN-153

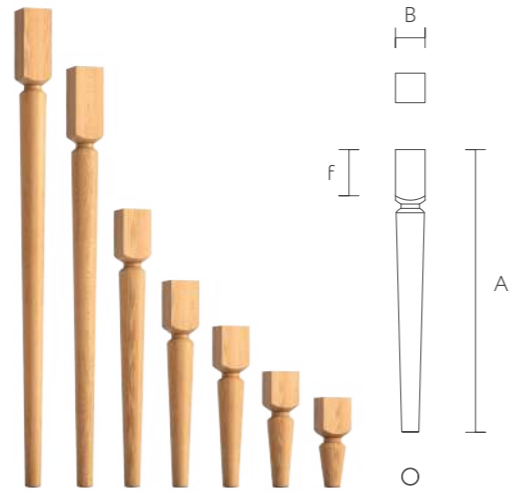

A	B	F	mm
140	45	50	mm
180	45	50	mm
250	45	60	mm
320	45	70	mm
430	45	70	mm
650	45	105	mm
740	45	105	mm

art. MN-140

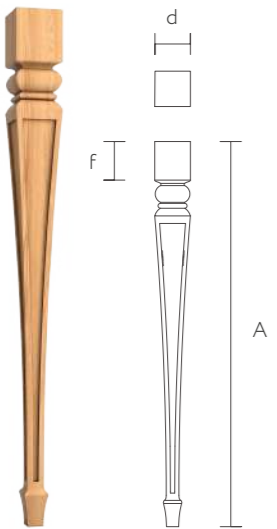

A	D	F	mm
1100	102	110	mm

art. MN-155

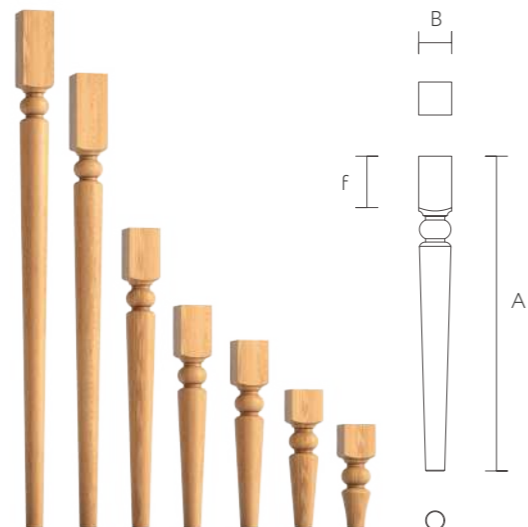

A	B	F	mm
150	45	44	mm
200	45	44	mm
270	45	60	mm
320	45	70	mm
430	45	70	mm
650	45	105	mm
740	45	105	mm



MLD-018

K-105

MN-155 (740\*45)

MN-155 (430\*45)



art. MN-104

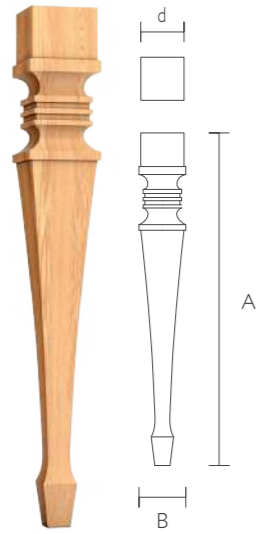

A	B	C	D	mm
740	104	104	96	

art. MN-105

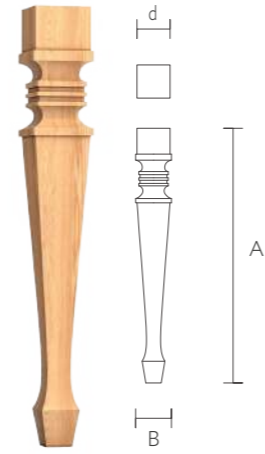

A	B	C	D	mm
430	61	61	56	

art. MN-102

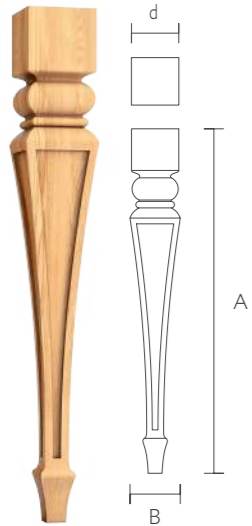

A	B	C	D	mm
740	108	108	102	

art. MN-103

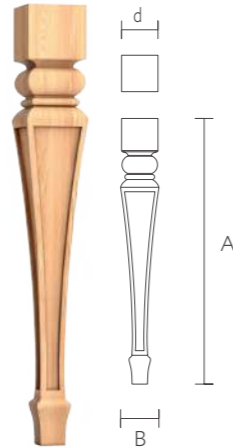

A	B	C	D	mm
430	62	62	59	

art. MN-132

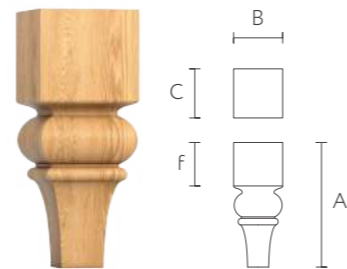

A	B	C	F	mm
160	63	63	56	





art. MN-106



A	B	C	D	mm
720	138	138	88	

art. MN-107



A	B	C	D	mm
390	92	92	66	

art. MN-112

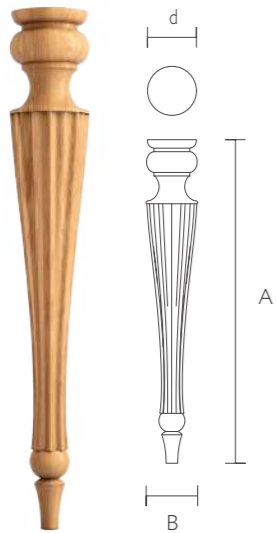

A	B	C	D	mm
720	114	114	109	

art. MN-113

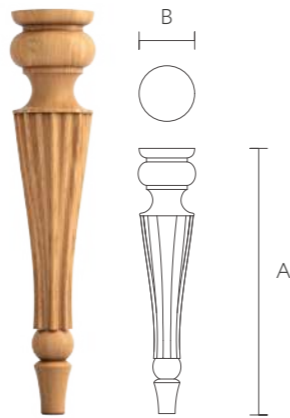

A	B	C	mm
390	81	81	



art. MN-116



A	B	D	mm
720	140	97	mm

art. MN-117



A	B	D	mm
390	90	69	mm

art. MN-143

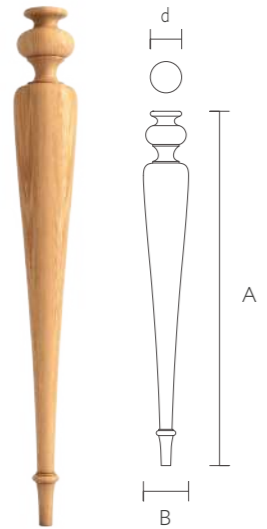

A	B	D	mm
1100	140	97	mm

art. MN-044

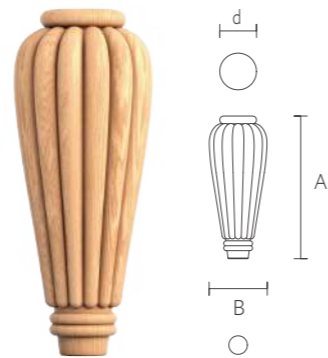

A	B	D	mm
140	57	36	mm
160	65	41	mm
200	81	51	mm





art. MN-144

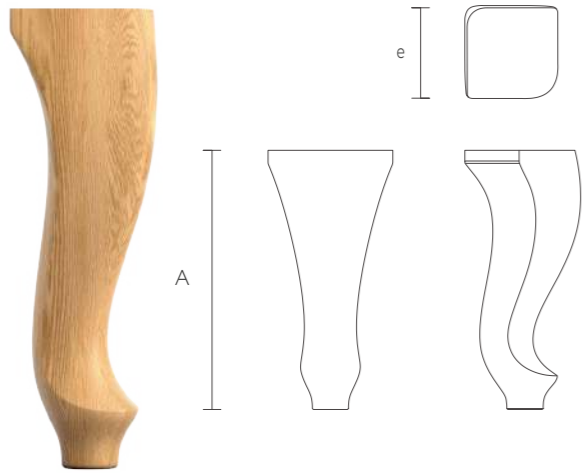

A	E	mm
200	70	mm
240	75	mm
270	85	mm

art. MN-147



A	B	E	mm
120	135	25	mm

art. MN-049

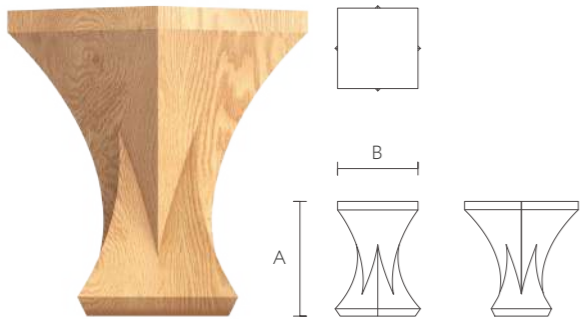

A	B	mm
120	84	mm

art. MN-054

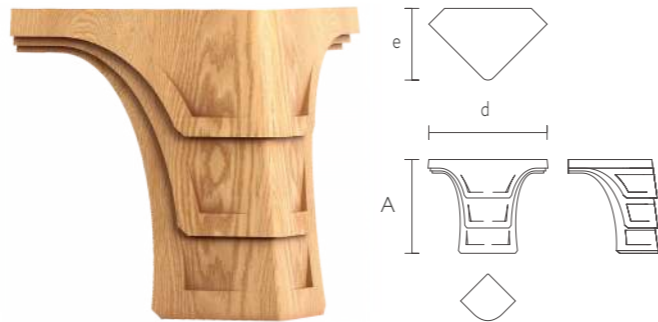

A	D	E	mm
97	122	74	mm





art. MN-152

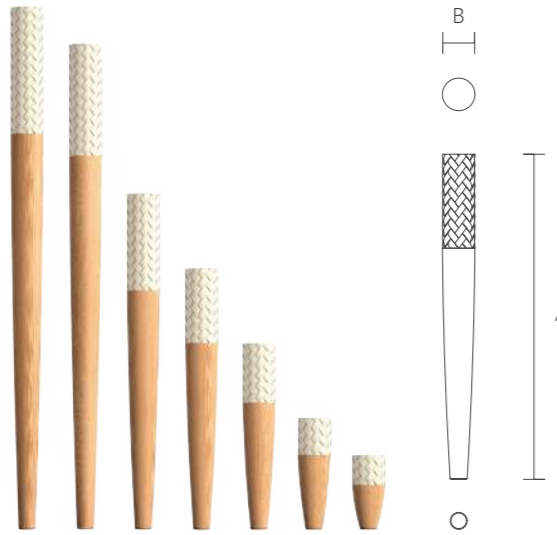

A	B	C	
100	45	24	mm
150	45	24	mm
250	45	24	mm
350	45	24	mm
450	45	24	mm
650	45	24	mm
700	45	24	mm
750	45	24	mm

art. MN-203

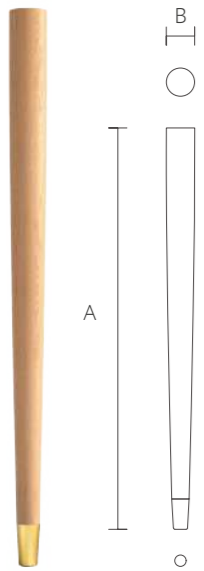

A	B	
740	52	mm

art. MN-199



A	B	C	D	
195	74	74	39	mm

art. MN-200

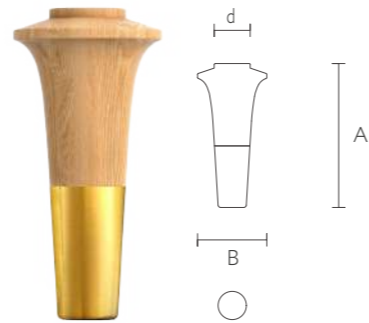

A	B	C	D	
130	63	63	33	mm





art. MN-193

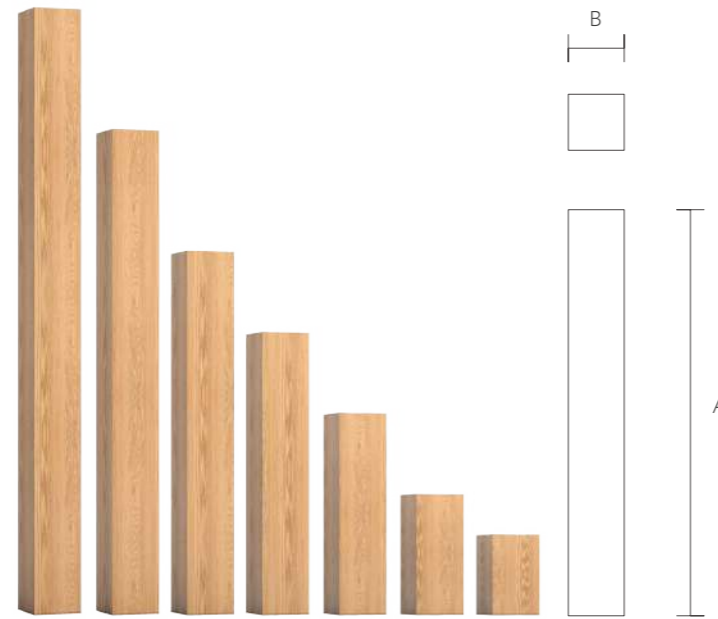

A	B	C	mm
100	62	62	mm
150	62	62	mm
250	62	62	mm
350	62	62	mm
450	62	62	mm
600	62	62	mm
750	62	62	mm

art. MN-194

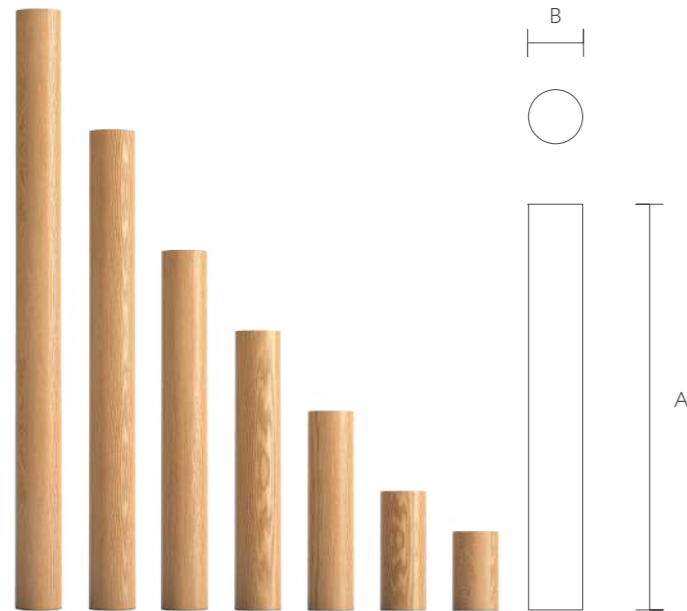

A	B	C	mm
100	60	60	mm
150	60	60	mm
250	60	60	mm
350	60	60	mm
450	60	60	mm
600	60	60	mm
750	60	60	mm













### **Санкт-Петербург**

(производство, шоу-рум)

Старо-Петергофский пр., д. 30,  
корпус 1 (далее 431 корп.)

+7 (812) 309-49-35

[info@stavros.ru](mailto:info@stavros.ru)

### **Москва** (шоу-рум)

Волоколамское шоссе, д. 3

+7 (495) 663-72-44

[msk@stavros.ru](mailto:msk@stavros.ru)

### **8 (800) 555-46-75**

звонки по всей России бесплатно

[www.stavros.ru](http://www.stavros.ru)