



Stavros®

Ценителям мастерства

НАКЛАДКИ

art. N-360



art. N-361



art. N-414



A	B	C	
307	154	16	mm
378	190	19	m
438	220	22	mm
498	250	25	mm
558	280	28	mm
612	307	31	mm
637	320	32	mm

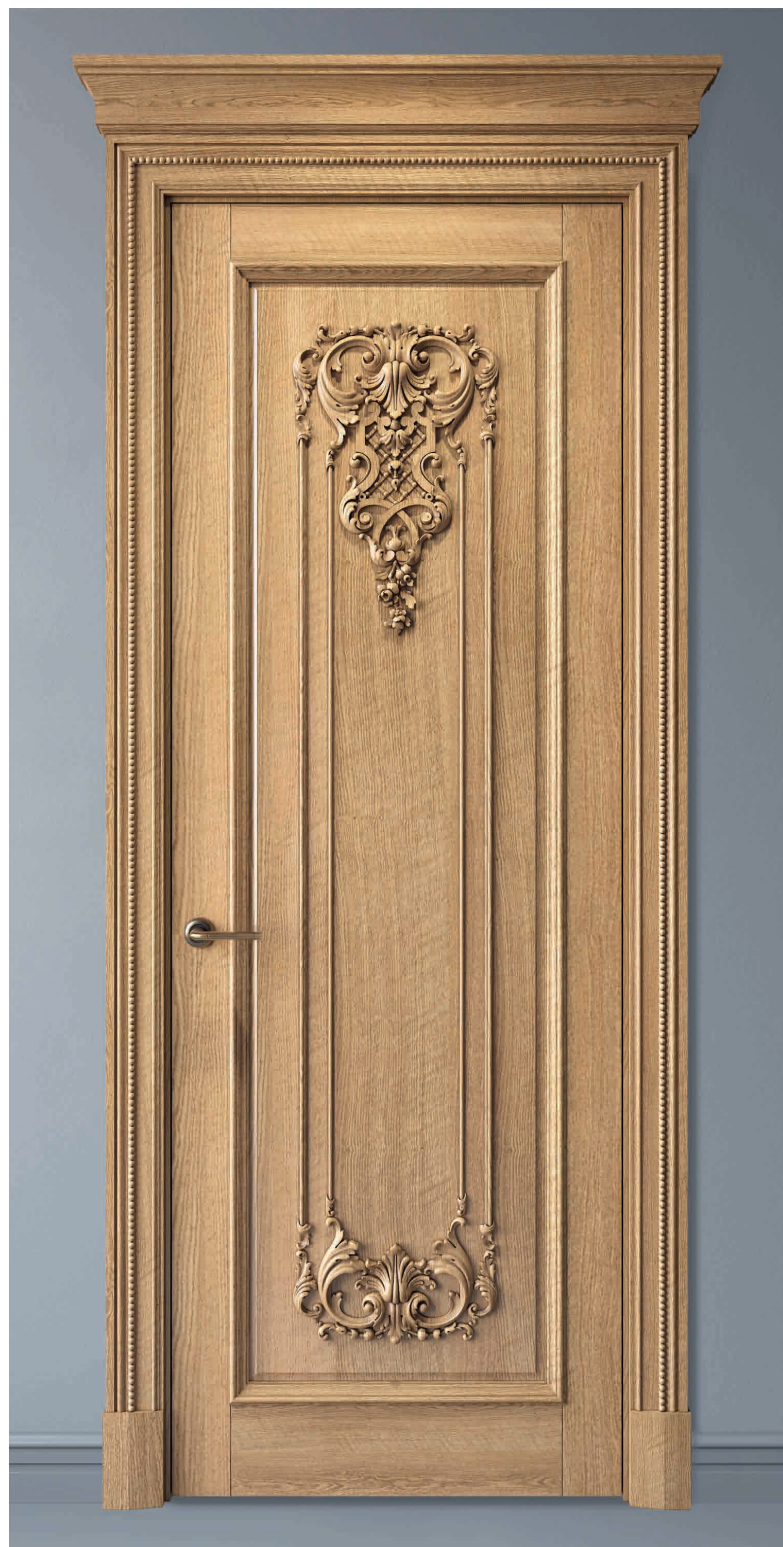

art. N-415

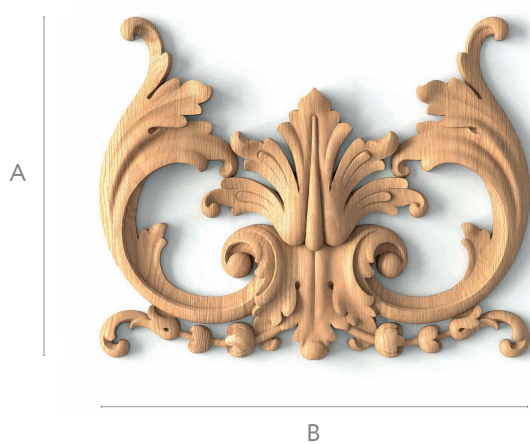

A	B	C	
122	154	16	mm
151	190	20	mm
175	220	23	mm
199	250	26	mm
222	280	29	mm
244	307	31	mm
254	320	33	mm



Комплект С-005-1-1

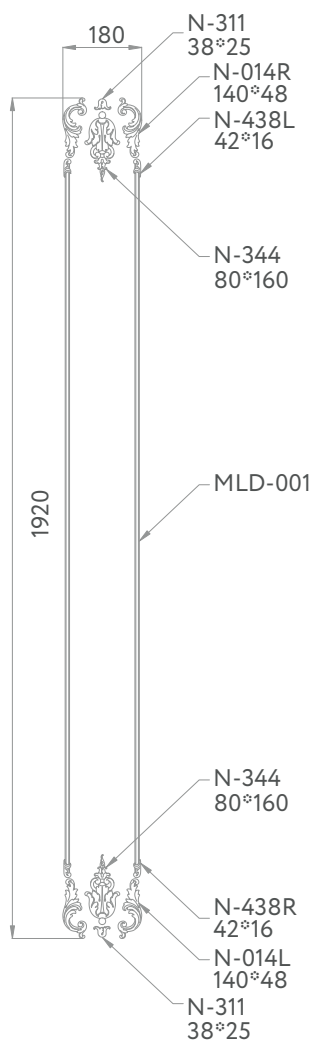

Комплект С-005-1-2

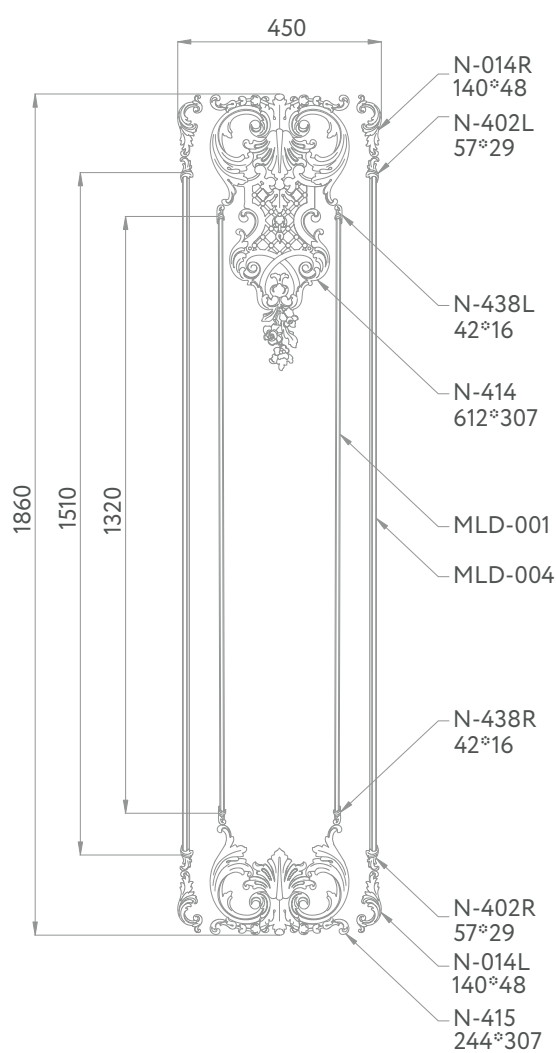

Комплект С-005-1-1

1. N - 014R (140*48) - 2 шт
2. N-438L (42*16) - 2 шт
3. MLD - 001 (10*2000) - 3200 мм
4. N - 438R (42*16) - 4 шт
5. N - 344 (80*160) - 2 шт
6. N - 311 (38*25) - 2 шт
7. N - 014L (140*48) - 2 шт

Комплект С-005-1-2

1. N - 014R (140*48) - 2 шт
2. N-402L (57*29) - 2 шт
3. MLD-004 (15*2400*8) - 3020 мм
4. N - 438R (42*16) - 2 шт
5. N - 415 (244*307) - 1 шт
6. N - 438L (42*16) - 2 шт
7. N-414 (612*307) - 1 шт
8. N-402R (57*29) - 2 шт
9. N-014L (140*48) - 2 шт
10. MLD-001 (10*2400*6) - 2650 мм

art. N-406



A	B	C	
280	136	13	mm
540	263	26	mm

art. N-407

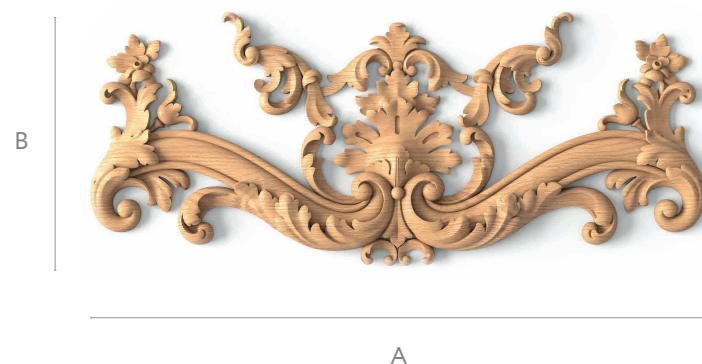

A	B	C	
280	115	13	mm
540	222	26	mm





Комплект С-004-1-1

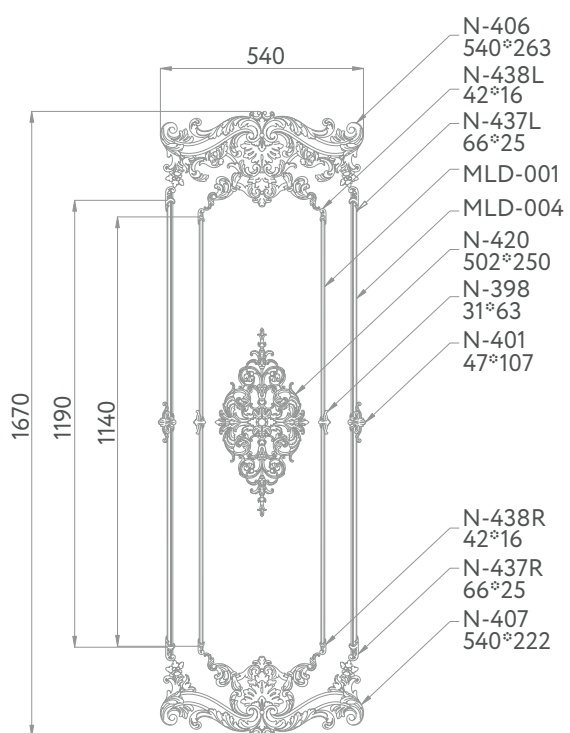

Комплект С-004-1-2

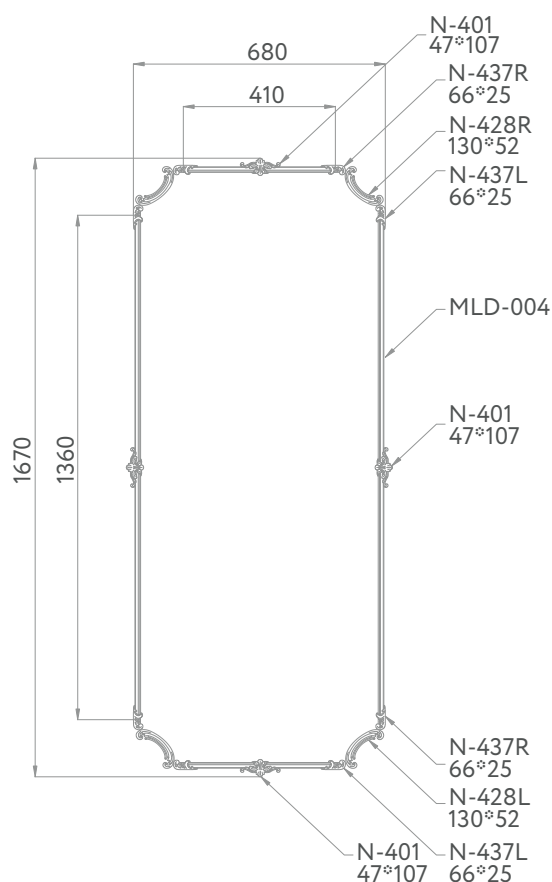

Комплект С-004-1-1

1. N - 406 (540*263) - 1 шт
2. N - 407 (540*222) - 1 шт
3. N - 437L (66*25) - 2 шт
4. N - 437R (66*25) - 2 шт
5. N - 438L (42*16) - 2 шт
6. N - 438R (42*16) - 2 шт
7. MLD-004 (15*2000)-2400 мм
8. MLD-001 (10*2000)-2300 мм
9. N - 401 (47*107) - 2 шт
10. N - 398 (31*63) - 2 шт
11. N-420 (502*250) - 1 шт

Комплект С-004-1-2

1. N - 437L (66*25) - 4 шт
2. N - 437R (66*25) - 4 шт
3. N - 401 (47*107) - 4 шт
4. N - 428L (130*52) - 2 шт
5. N - 428R (130*52) - 2 шт
6. MLD-004 (15*2000)-3600 мм

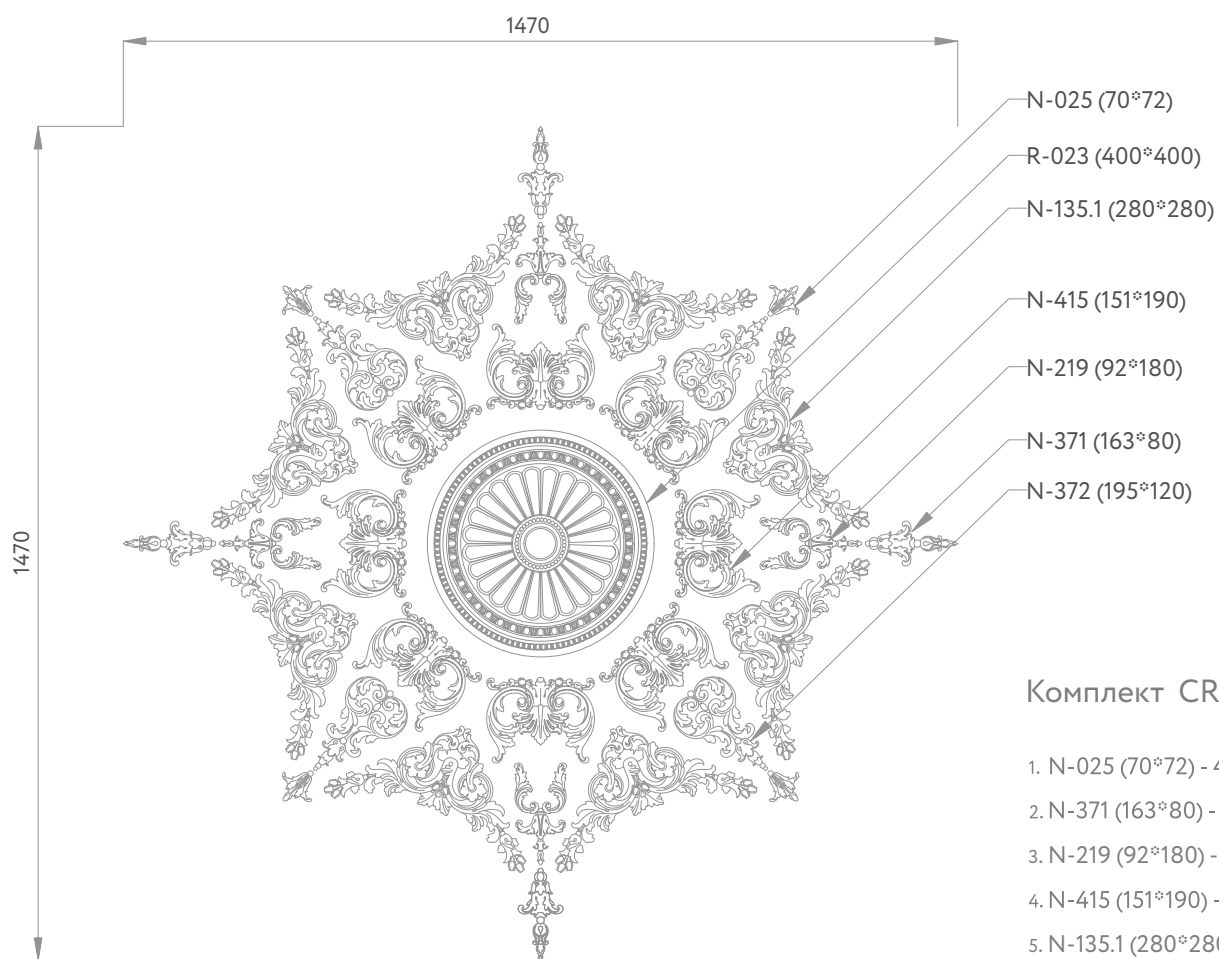

Комплект CR-02-1.1

- 1. N-025 (70*72) - 4 шт
- 2. N-371 (163*80) - 4 шт
- 3. N-219 (92*180) - 4 шт
- 4. N-415 (151*190) - 8 шт
- 5. N-135.1 (280*280) - 8 шт
- 6. N-372 (195*120) - 4 шт
- 7. R-023 (400*400) - 1 шт

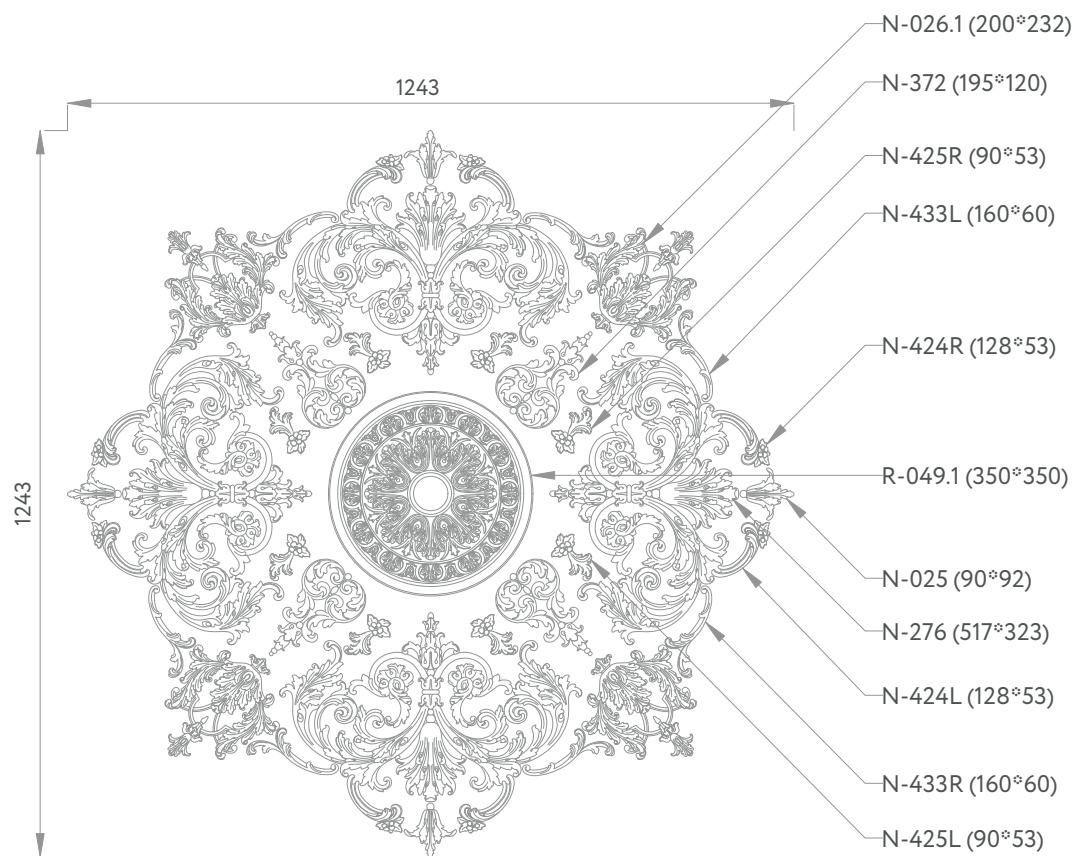

Комплект CR-01-1

1. N - 025(90*92) - 4 шт
2. N - 424L(128*53) - 4 шт
3. N - 424R(128*53) - 4 шт
4. N - 425L(90*53) - 4 шт
5. N - 425R(90*53) - 4 шт
6. N - 372(195*120) - 4 шт
7. N - 276(517*323) - 4 шт
8. N - 433R(160*60) - 4 шт
9. N - 433L(160*60) - 4шт
10. N - 026.1(200*232) - 4 шт
11. R - 049.1(350*350) - 1 шт



art. N-186L



A	B	C	
170	63	11	mm
230	85	14	mm
290	107	18	mm



art. N-186R

art. N-158L



A	B	C	
181	60	9	mm
211	70	10	mm
301	100	14	mm
392	130	18	mm



art. N-158R

art. N-206L



A	B	C	
170	69	11	mm
230	93	15	mm
300	121	20	mm



art. N-206R

art. N-184L



A	B	C	L	
240	220	14	313	mm
279	256	16	363	mm
350	321	20	456	mm



art. N-184R

art. N-014L



A	B	C	
90	31	10	mm
110	38	12	mm
140	48	15	mm
200	69	21	mm



art. N-014R

art. N-209L

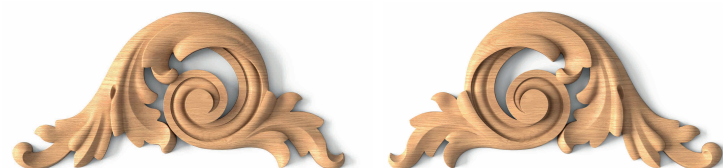

A	B	C	
100	48	9	mm
200	95	18	mm



art. N-209R

art. N-247L



A	B	C	
106	45	10	mm
188	80	18	mm
247	105	23	mm



art. L-247R

art. N-120L



A	B	C	
150	59	10	mm
225	88	15	mm
250	98	16	mm



art. N-120R

art. N-015L

art. N-015R

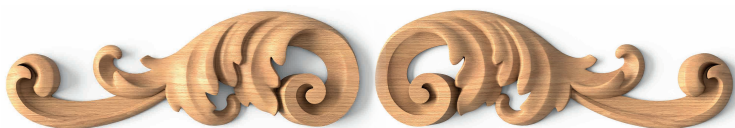

A	B	C	mm
150	50	12	mm



art. N-013L

art. N-013R

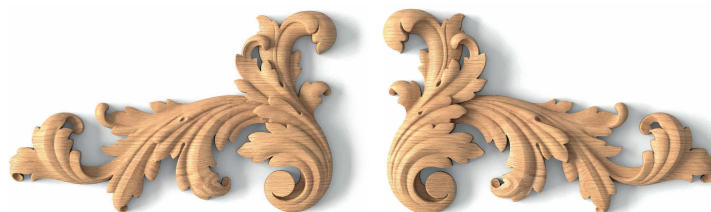

A	B	C	mm
150	92	14	mm
200	123	19	mm
250	154	24	mm



art. N-212L

art. N-212R



A	B	C	L	mm
120	115	17	155	mm
160	153	23	208	mm
220	210	31	286	mm



art. N-221L

art. N-221R



A	B	C	L	mm
60	70	6	82	mm
70	82	7	95	mm
80	93	8	109	mm
90	105	9	123	mm
100	116	10	136	mm

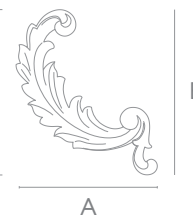

art. N-458L

art. N-458R



A	B	C	mm
190	68	12	mm
251	90	16	mm



art. N-459L

art. N-459R



A	B	C	L	mm
159	84	13	173	mm
210	111	17	230	mm



art. N-174L

art. N-174R



A	B	C	mm
46	120	9	mm
81	210	16	mm

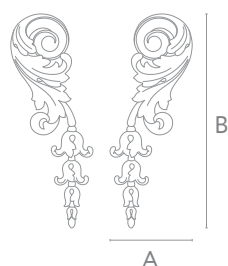

art. N-022L

art. N-022R



A	B	C	mm
80	210	11	mm
100	263	14	mm
165	434	23	mm

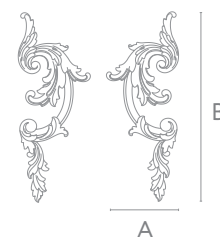

art. N-461L



art. N-461R



A	B	C	
195	112	13	mm
258	148	17	mm



art. N-066L



art. N-066R



A	B	C	L	
180	118	16	196	mm
215	140	19	235	mm
300	196	26	327	mm



art. N-161.1L



art. N-161.1R



A	B	C	L	
90	61	13	90	mm

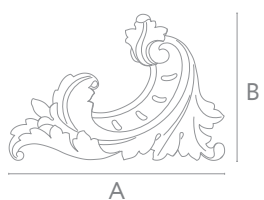

art. N-016L



art. N-016R



A	B	C	
80	118	13	mm
130	192	21	mm



art. N-460L



art. N-460R



A	B	C	
260	94	13	mm
343	124	17	mm



art. N-423L



art. N-423R



A	B	C	
336	58	13	mm
453	78	17	mm



art. N-427L



art. N-427R



A	B	C	
357	78	16	mm
482	105	22	mm



art. N-429L



art. N-429R



A	B	C	
244	61	16	mm
329	82	22	mm



art. N-433L

art. N-433R



A	B	C	
160	60	11	mm
215	81	15	mm



art. N-432L

art. N-432R



A	B	C	
132	36	11	mm
177	49	15	mm

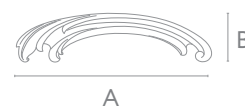

art. N-430L

art. N-430R



A	B	C	
225	64	14	mm
303	87	19	mm



art. N-431L

art. N-431R



A	B	C	
138	48	11	mm
185	65	15	mm



art. N-426L

art. N-426R



A	B	C	
275	79	16	mm
370	106	22	mm



art. N-425L

art. N-425R

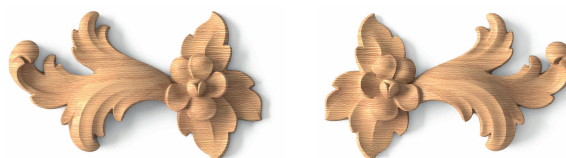

A	B	C	
90	53	12	mm
121	72	16	mm



art. N-424L

art. N-424R



A	B	C	
128	53	15	mm
172	71	20	mm



art. N-428L

art. N-428R



A	B	C	
130	52	11	mm
175	70	15	mm

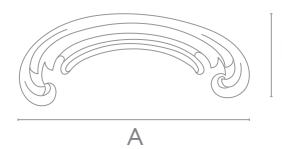

art. N-281L

art. N-281R

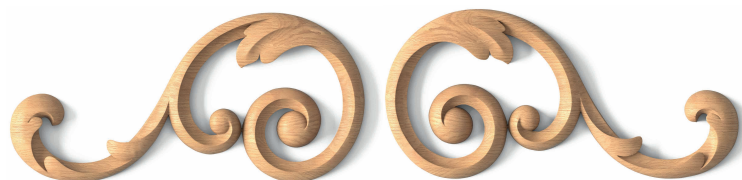

A	B	C	
153	73	10	mm
295	141	18	mm



art. N-282L

art. N-282R

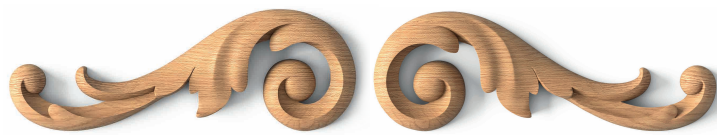

A	B	C	
116	41	10	mm
148	52	12	mm
222	78	18	mm



art. N-283L

art. N-283R

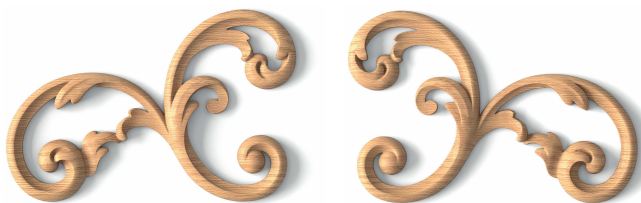

A	B	C	L	
151	100	10	162	mm
290	193	18	309	mm

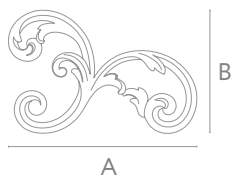

art. N-284L

art. L-284R



A	B	C	
176	69	9	mm
339	133	17	mm



art. N-285L

art. L-285R



A	B	C	L	
109	120	9	152	mm
139	153	11	193	mm
210	231	16	292	mm
252	277	19	352	mm

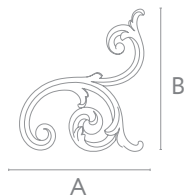

art. N-286L

art. L-286R



A	B	C	
154	80	9	mm
197	103	11	mm
296	154	16	mm



art. N-288L

art. N-288R



A	B	C	
83	44	9	mm
105	56	12	mm
127	67	14	mm

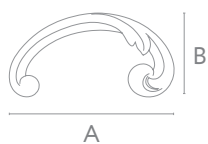

art. N-290L

art. N-290R



A	B	C	
158	45	10	mm
202	58	12	mm



art. N-291L

art. N-291R



A	B	C	
125	63	9	mm
240	122	16	mm
288	146	19	mm



art. N-295L

art. N-295R

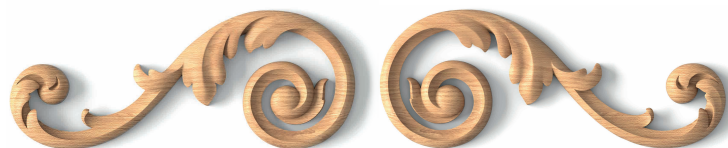

A	B	C	
172	69	10	mm
219	88	13	mm
264	106	15	mm

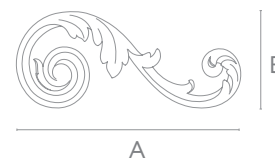

art. N-292L

art. N-292R



A	B	C	
120	81	9	mm
231	155	16	mm



art. N-293L

art. N-293R



A	B	C	
133	61	9	mm
256	118	16	mm

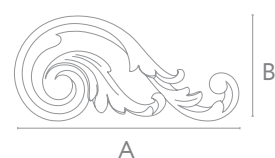

art. N-298L

art. N-298R



A	B	C	
171	80	10	mm
329	153	18	mm



art. N-305



A	B	C	
81	46	8	mm
104	59	10	mm
156	89	14	mm

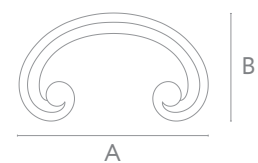

art. N-296L

art. N-296R



A	B	C	L	
179	97	9	193	mm
344	187	16	368	mm

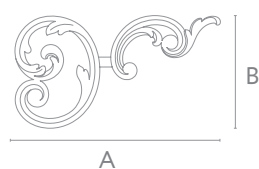

art. N-297L

art. N-297R

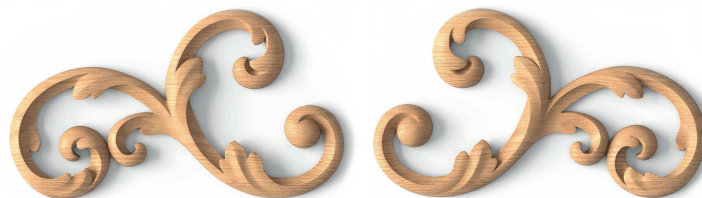

A	B	C	
145	82	9	mm
279	159	17	mm



art. N-302

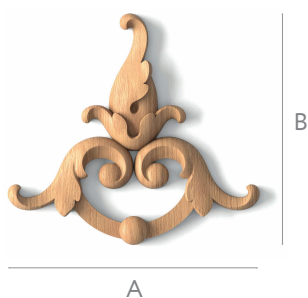

A	B	C	
84	77	8	mm

art. N-303L



A	B	C	
55	62	8	mm
71	80	11	mm

art. N-303R



A	B	C	
55	62	8	mm
71	80	11	mm

art. N-300

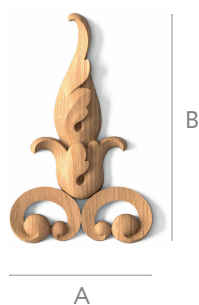

A	B	C	
55	89	8	mm
106	172	16	mm

art. N-312



A	B	C	
18	58	8	mm

art. N-307

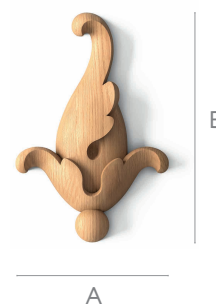

A	B	C	
35	53	9	mm
54	81	13	mm

art. N-301

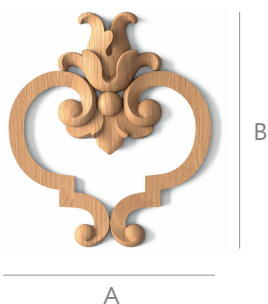

A	B	C	
88	103	10	mm
132	154	15	mm

art. N-313

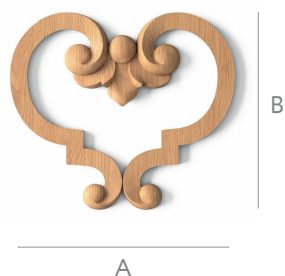

A	B	C	
69	60	6	mm
132	116	11	mm

art. N-308

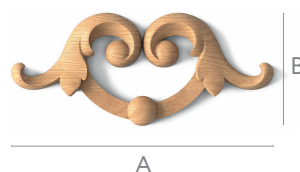

A	B	C	
84	36	8	mm
129	56	13	mm

art. N-304

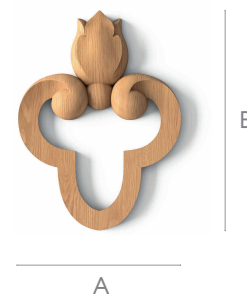

A	B	C	
49	67	9	mm

art. N-325

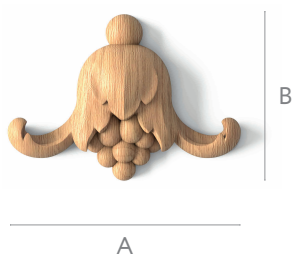

A	B	C	
77	55	18	mm

art. N-311



A	B	C	
38	25	9	mm
58	38	13	mm

art. N-310

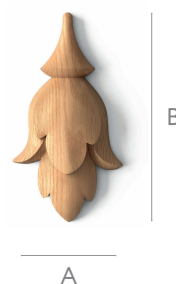

A	B	C	
22	42	8	mm
28	53	9	mm

art. N-306



A	B	C	
18	31	9	mm
22	38	10	mm
27	46	13	mm

art. N-369L



A	B	C	L	
126	96	9	143	mm
203	155	14	230	mm

art. N-369R

art. N-373L

art. N-373R



A	B	C	
129	65	10	mm
207	104	15	mm

art. N-370L

art. N-370R

art. N-371

art. N-372



A	B	C	
120	40	11	mm
210	84	21	mm



A	B	C	
163	80	13	mm



A	B	C	
120	75	10	mm
195	120	16	mm

art. N-386

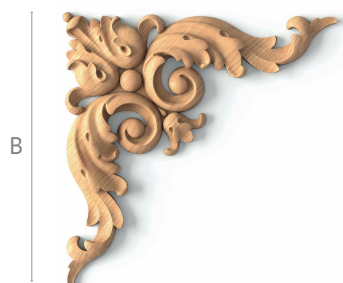

A	B	C	L	
165	165	12	226	mm
230	230	20	315	mm

art. N-224



A	B	C	
470	205	21	mm
570	249	25	mm
670	292	30	mm

art. N-088.1

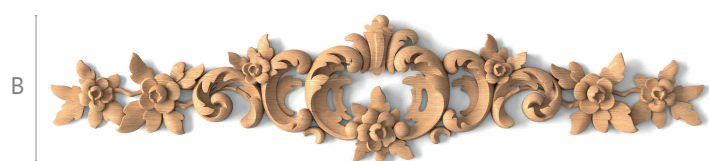

A	B	C	
600	136	20	mm
700	159	24	mm
858	195	30	mm

art. N-043

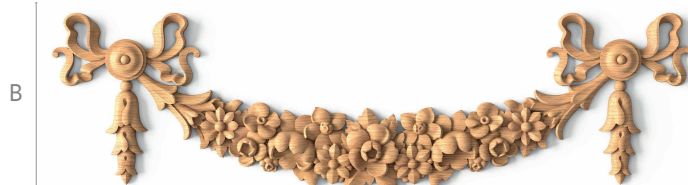

A	B	C	
300	83	12	mm
360	100	14	mm
424	118	17	mm
500	139	20	mm

art. N-091.1

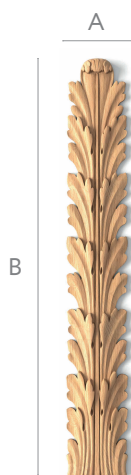

A	B	C	
42	275	9	mm
53	343	11	mm
84	547	18	mm

art. N-090.1

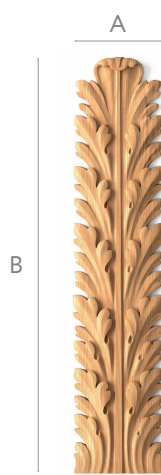

A	B	C	
45	205	8	mm
60	273	10	mm
80	364	13	mm
100	455	17	mm
140	637	23	mm

art. N-315L

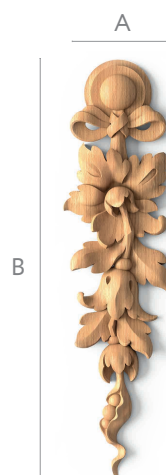

A	B	C	
40	158	12	mm
50	197	15	mm
60	237	18	mm
80	316	23	mm

art. N-315R

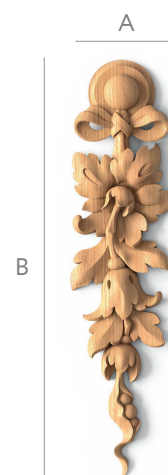

A	B	C	
40	158	12	mm
50	197	15	mm
60	237	18	mm
80	316	23	mm

art. N-017

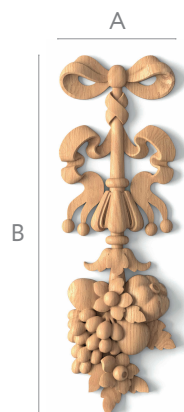

A	B	C	
60	186	16	mm
80	248	21	mm
110	341	29	mm
140	434	37	mm

art. N-198

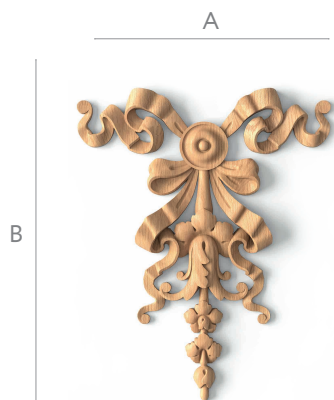

A	B	C	
140	172	13	mm
200	245	18	mm
230	282	21	mm

art. N-042

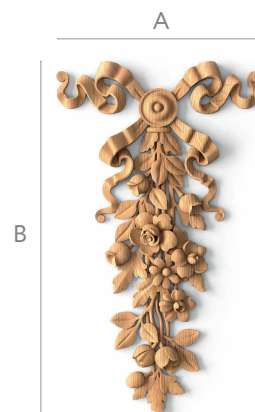

A	B	C	
140	243	14	mm
180	313	18	mm
220	383	22	mm
300	522	30	mm

art. N-126.1

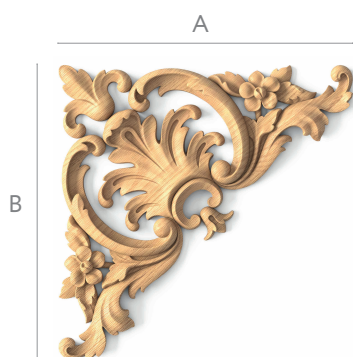

A	B	C	L	
110	110	9	146	mm
130	130	11	173	mm
150	150	13	200	mm
200	200	17	267	mm

art. N-200

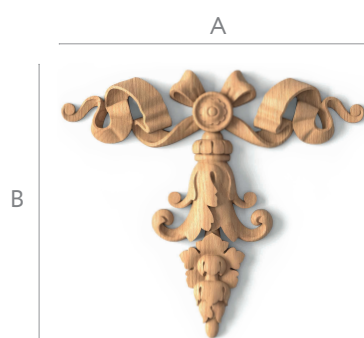

A	B	C	
130	115	12	mm
190	168	17	mm

art. N-375

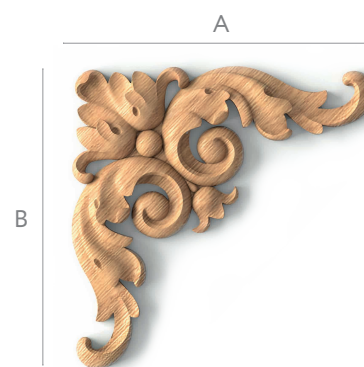

A	B	C	L	
100	100	10	134	mm
140	140	16	187	mm

art. N-388

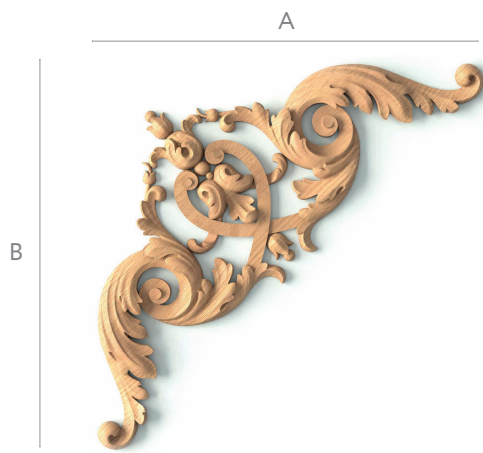

A	B	C	L	
200	200	11	276	mm
250	250	14	345	mm
300	300	17	414	mm

art. N-389

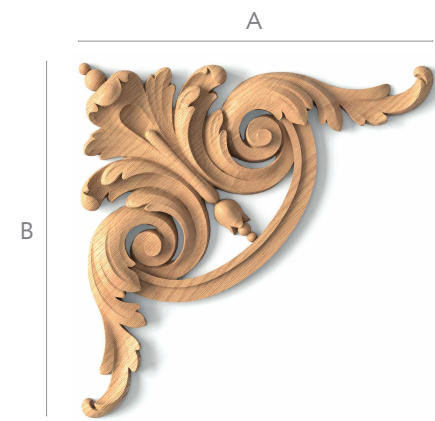

A	B	C	L	
120	120	12	165	mm
150	150	15	206	mm
200	200	20	275	mm

art. N-390

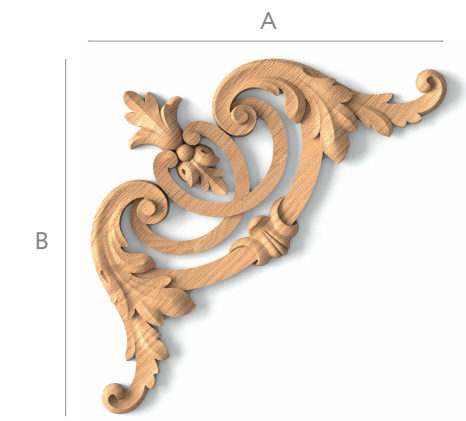

A	B	C	L	
140	140	10	187	mm
170	170	13	227	mm
200	200	15	266	mm

art. N-395

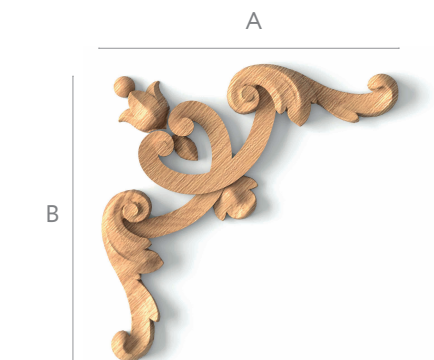

A	B	C	L	
90	90	9	119	mm
110	110	10	145	mm
120	120	11	158	mm

art. N-393



A	B	C	L	
80	80	8	109	mm
120	120	12	163	mm

art. N-396

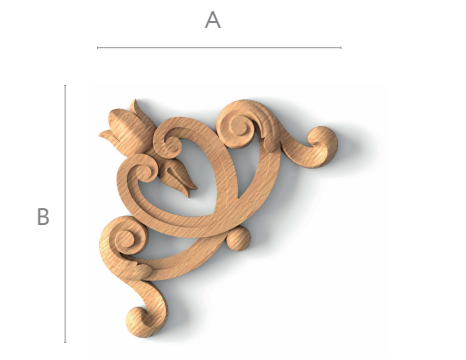

A	B	C	L	
60	60	8	72	mm
85	85	11	101	mm

art. N-009

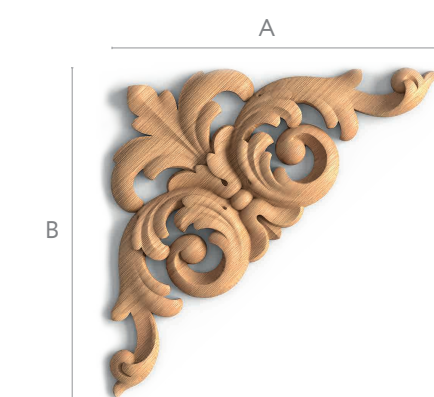

A	B	C	L	
90	90	8	124	mm
110	110	9	152	mm
150	150	12	207	mm

art. N-041

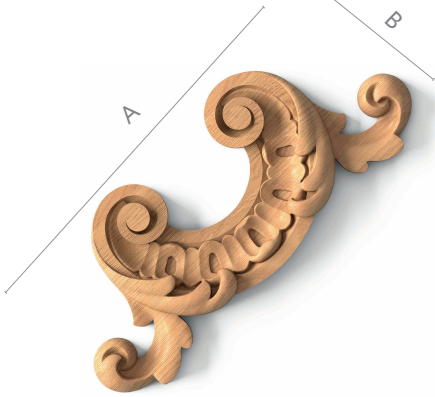

A	B	C	
100	41	12	mm
145	60	17	mm
170	70	20	mm

art. N-202

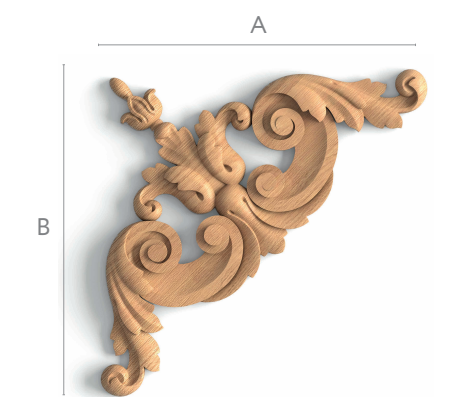

A	B	C	L	
80	80	7	109	mm
90	90	8	123	mm
100	100	9	137	mm
120	120	11	164	mm
150	150	13	205	mm
180	180	17	246	mm

art. N-003

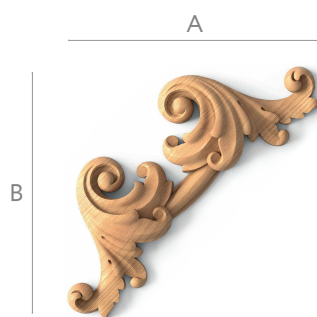

A	B	C	L	
110	110	16	146	mm
130	130	19	173	mm
170	170	25	226	mm

art. N-168.1

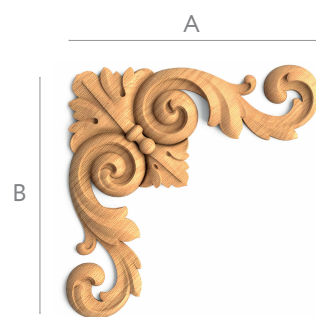

A	B	C	L	
70	70	7	92	mm
90	90	9	118	mm
110	110	11	144	mm
150	150	15	200	mm

art. N-358

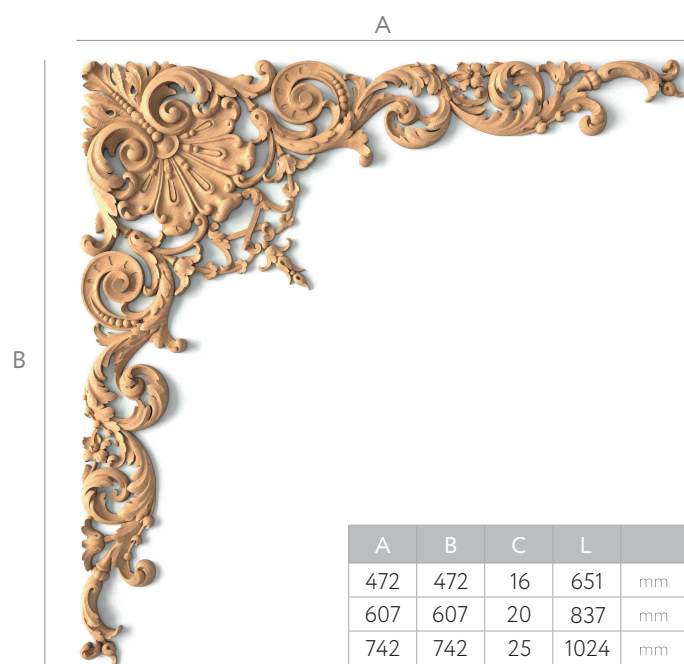

A	B	C	L	
472	472	16	651	mm
607	607	20	837	mm
742	742	25	1024	mm

art. N-132

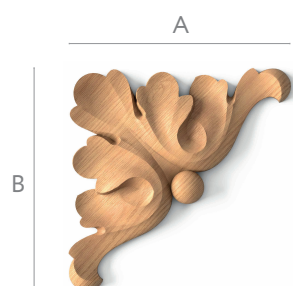

A	B	C	L	
50	50	7	67	mm
60	60	8	81	mm
80	80	11	108	mm
100	100	14	134	mm

art. N-213

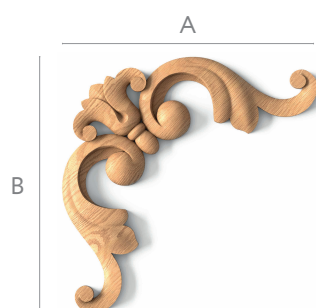

A	B	C	L	
80	80	8	103	mm
90	90	9	116	mm
105	105	10	135	mm
121	121	12	155	mm
160	160	16	206	mm

art. N-135.1

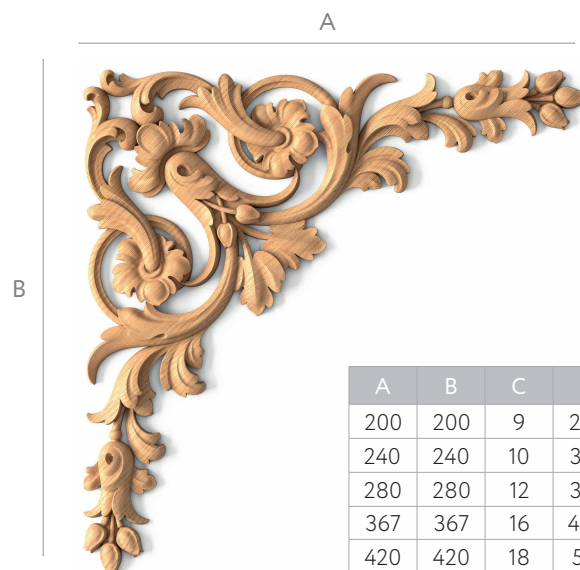

A	B	C	L	
200	200	9	273	mm
240	240	10	327	mm
280	280	12	381	mm
367	367	16	499	mm
420	420	18	571	mm

art. N-133.1



A	B	C	L	
80	80	7	105	mm
100	100	9	131	mm
120	120	10	158	mm
140	140	12	184	mm
160	160	14	210	mm
230	230	20	302	mm

art. N-357

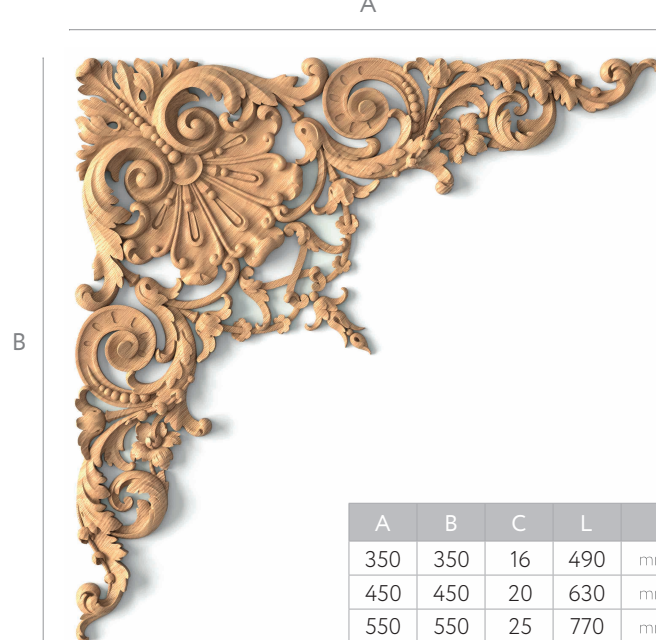

A	B	C	L	
350	350	16	490	mm
450	450	20	630	mm
550	550	25	770	mm

art. N-227

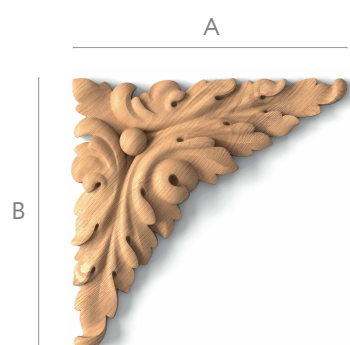

A	B	C	L	
90	89	11	123	mm
120	118	15	165	mm
131	129	16	180	mm
160	158	20	220	mm

art. N-193

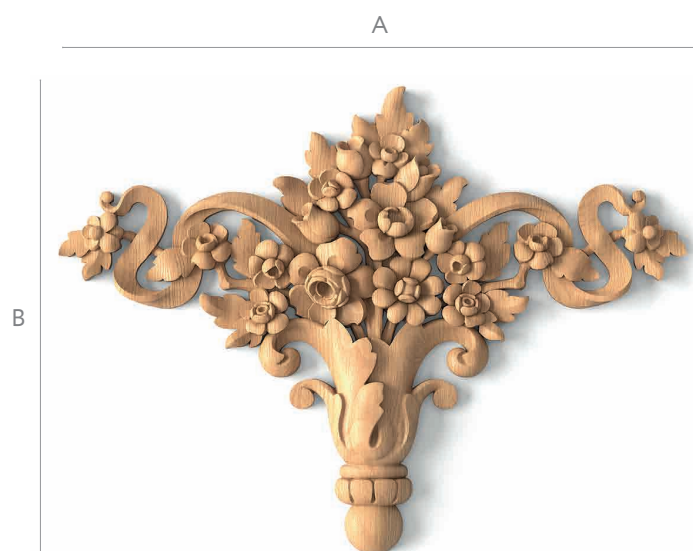

A	B	C	
260	194	19	mm
369	275	28	mm

art. N-027

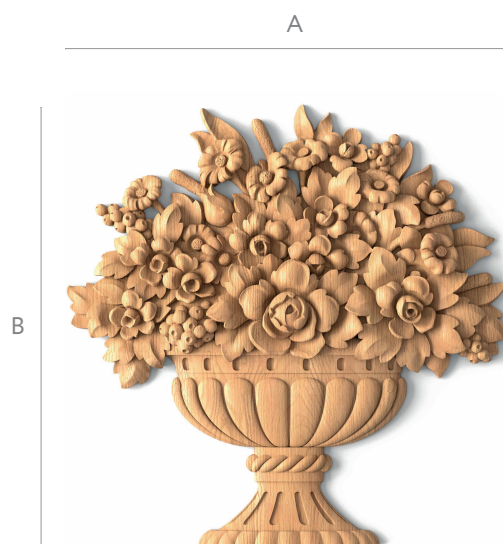

A	B	C	
230	230	27	mm
270	270	32	mm
350	350	41	mm

art. N-018

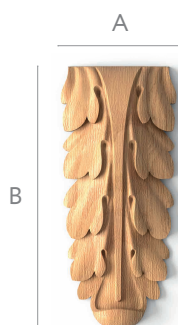

A	B	C	
30	68	11	mm
40	90	15	mm
50	114	18	mm
67	152	25	mm
80	181	30	mm
90	204	34	mm

art. N-089

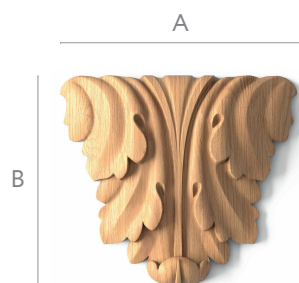

A	B	C	
70	62	14	mm
90	80	20	mm
120	107	27	mm

art. N-109

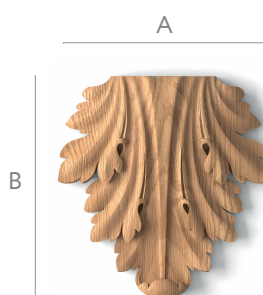

A	B	C	
50	53	8	mm
60	63	9	mm
70	74	11	mm
80	85	13	mm
100	106	16	mm

art. N-129



A	B	C	
40	55	9	mm
50	69	11	mm
62	85	14	mm
80	110	18	mm
110	151	25	mm

art. N-381

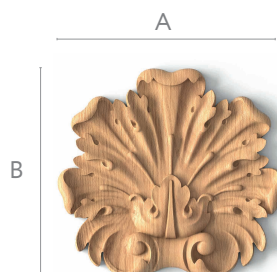

A	B	C	
120	110	14	mm
190	180	20	mm

art. N-110

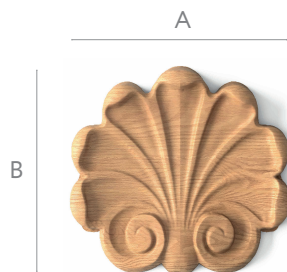

A	B	C	
60	57	11	mm
93	88	17	mm
120	114	22	mm

art. N-192

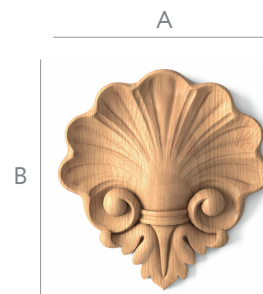

A	B	C	
80	83	13	mm
130	134	22	mm

art. N-233

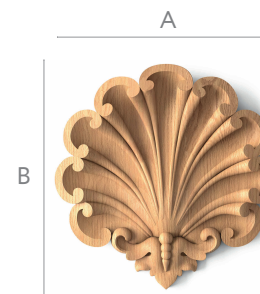

A	B	C	
110	112	16	mm
134	136	19	mm
160	162	22	mm

art. N-242

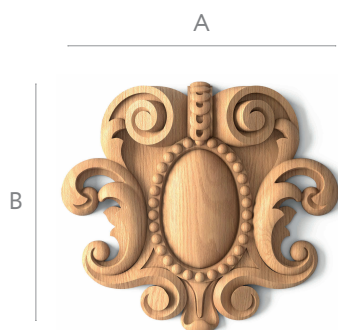

A	B	C	
110	99	17	mm
145	131	22	mm
170	154	26	mm
200	181	30	mm
300	271	43	mm

art. N-267



A	B	C	
134	100	11	mm
161	120	13	mm
190	142	15	mm
220	165	17	mm
254	190	20	mm
293	220	23	mm
361	270	29	mm

art. N-197

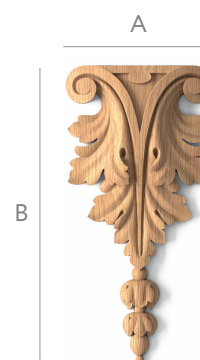

A	B	C	
45	91	10	mm
55	111	12	mm
65	131	14	mm
75	151	16	mm
85	172	19	mm
95	192	21	mm
120	243	27	mm
140	283	31	mm

art. N-346

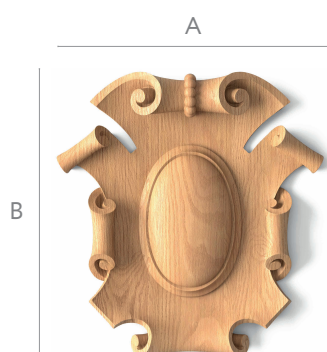

A	B	C	
138	145	24	mm
161	170	28	mm
232	244	40	mm

art. N-229

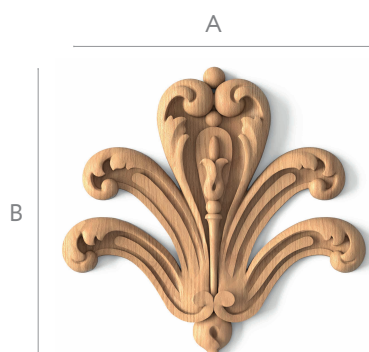

A	B	C	
110	106	11	mm
150	145	15	mm

art. N-108

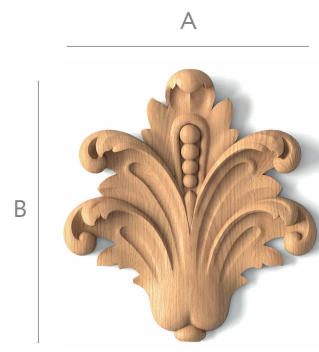

A	B	C	
70	75	11	mm
85	91	13	mm
100	107	15	mm
130	139	20	mm

art. N-001

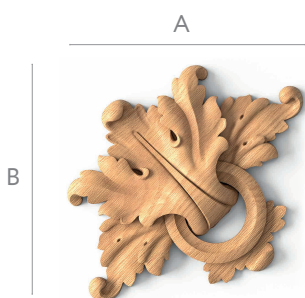

A	B	C	L	
70	70	11	87	mm
127	127	19	158	mm

art. N-002

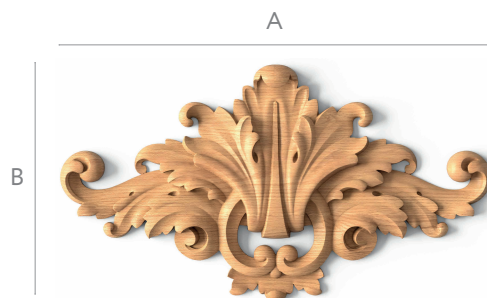

A	B	C	
140	77	12	mm
160	88	14	mm
200	110	17	mm
240	132	21	mm
288	158	25	mm
350	192	30	mm

art. N-006

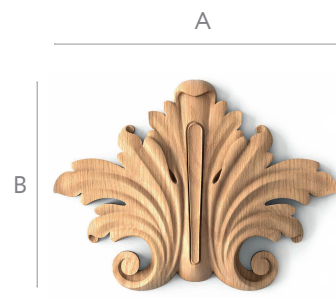

A	B	C	
110	82	17	mm
140	104	22	mm
170	126	27	mm

art. N-149



A	B	C	
150	225	10	mm
210	315	11	mm
274	411	15	mm
320	480	18	mm

art. N-280



A	B	C	
180	327	21	mm
260	472	30	mm

art. N-231

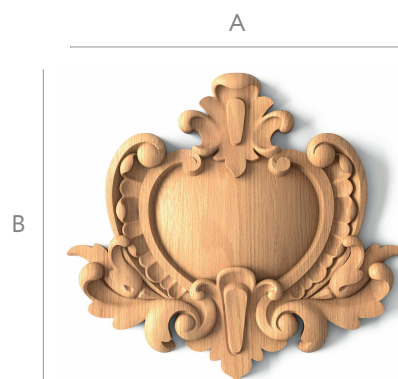

A	B	C	
140	126	17	mm
170	153	20	mm
200	180	24	mm
235	211	28	mm
330	296	39	mm

art. N-203



A	B	C	
90	52	10	mm
122	71	14	mm
160	93	18	mm

art. N-314



A	B	C	
132	90	11	mm
161	110	13	mm
264	180	20	mm

art. N-345



A	B	C	
150	110	24	mm
200	147	32	mm
305	223	49	mm
350	257	56	mm

art. N-047



A	B	C	
300	146	16	mm
450	219	24	mm
550	267	29	mm

art. N-115

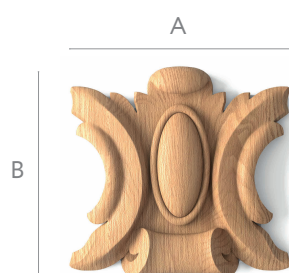

A	B	C	
86	84	14	mm

art. N-387



A	B	C	
150	110	15	mm
250	183	24	mm
320	235	31	mm

art. N-113

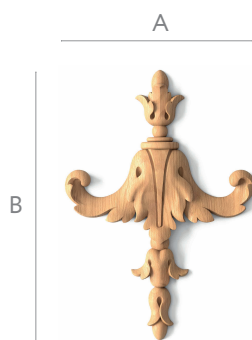

A	B	C	
65	93	8	mm
110	157	13	mm

art. N-025

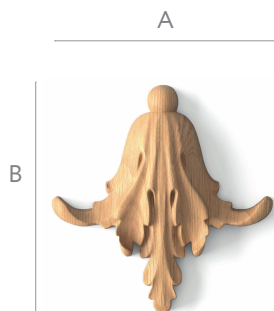

A	B	C	
70	72	14	mm
90	92	18	mm

art. N-142.1

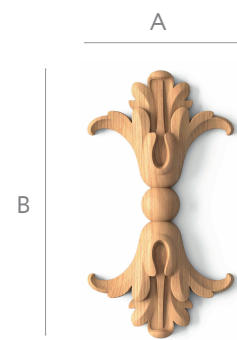

A	B	C	
36	66	7	mm
46	84	9	mm
60	110	12	mm

art. N-112

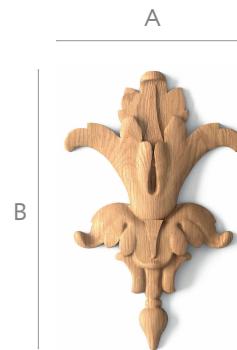

A	B	C	
50	78	9	mm
80	125	14	mm

art. N-225

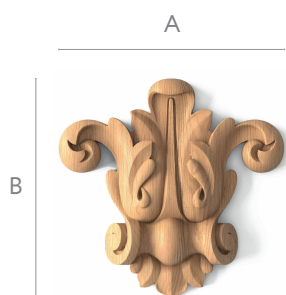

A	B	C	
70	68	13	mm
90	88	17	mm
110	107	21	mm

art. N-190

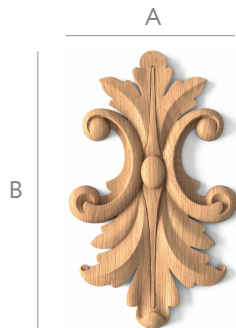

A	B	C	
50	82	8	mm
69	114	11	mm
88	145	14	mm

art. N-094

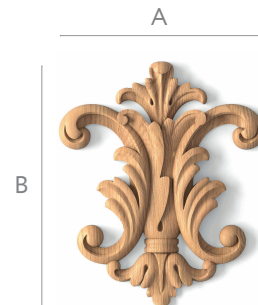

A	B	C	
90	108	11	mm
110	132	12	mm
130	156	14	mm
160	193	17	mm

art. N-352

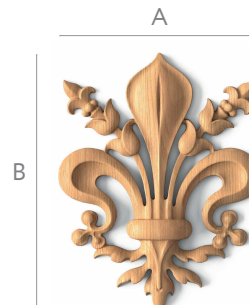

A	B	C	
77	99	12	mm
90	115	14	mm
150	192	23	mm

art. N-087

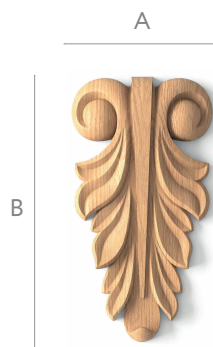

A	B	C	
45	84	11	mm
55	103	13	mm
64	120	15	mm
80	150	19	mm

art. N-153

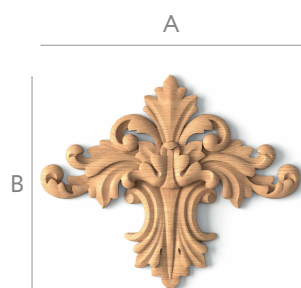

A	B	C	
130	107	9	mm
230	190	16	mm
270	223	19	mm

art. N-244

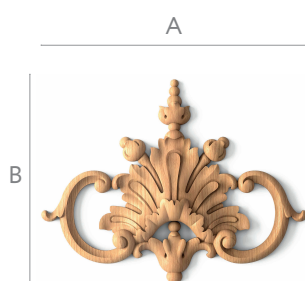

A	B	C	
110	84	11	mm
130	100	13	mm
180	138	18	mm
210	161	21	mm
240	184	24	mm
270	207	27	mm

art. N-169.1

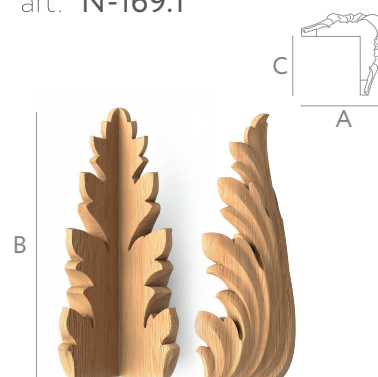

A	B	C	
41	110	29	mm
48	130	35	mm
59	160	43	mm

art. N-219

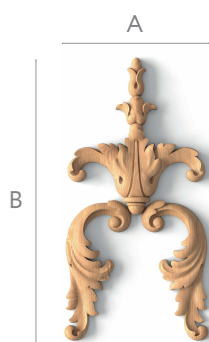

A	B	C	
73	143	11	mm
92	180	14	mm

art. N-131

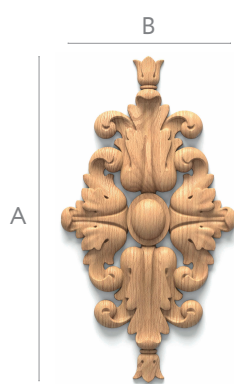

A	B	C	
150	80	11	mm
200	107	14	mm
300	160	21	mm

art. N-216

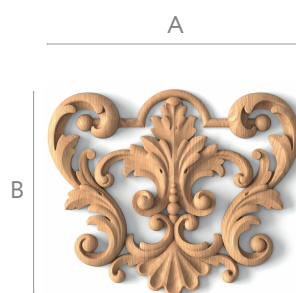

A	B	C	
140	115	13	mm
180	148	17	mm
250	205	23	mm

art. N-010



A	B	C	
140	95	9	mm
170	115	10	mm
200	136	12	mm
246	167	15	mm

art. N-020

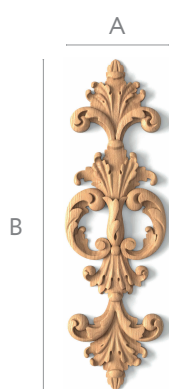

A	B	C	
80	262	12	mm

art. N-211

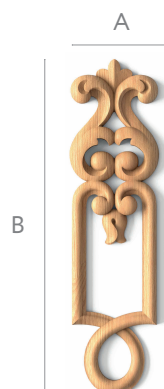

A	B	C	
40	151	9	mm
55	207	12	mm
74	279	16	mm

art. N-210

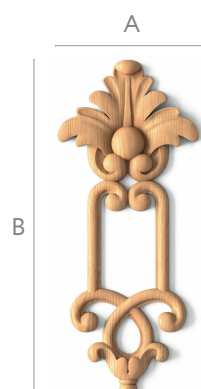

A	B	C	
66	158	9	mm
90	216	13	mm
120	288	17	mm

art. N-222



A	B	C	
136	50	9	mm
190	70	13	mm
271	100	19	mm

art. N-271

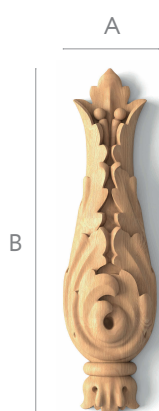

A	B	C	
30	112	16	mm
50	187	26	mm
70	261	36	mm

art. N-021

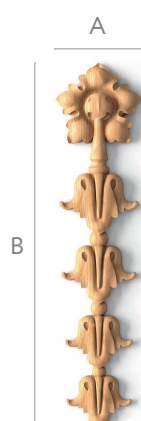

A	B	C	
30	129	9	mm
40	171	11	mm
50	214	14	mm

art. N-316

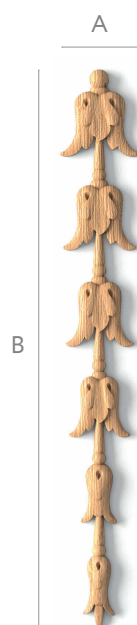

A	B	C	
28	200	6	mm

art. N-171

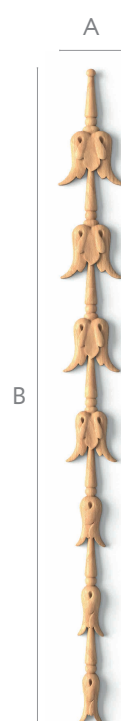

A	B	C	
40	395	7	mm
51	503	9	mm
60	592	11	mm
80	789	14	mm

art. N-238



A	B	C	
170	216	15	mm
200	254	18	mm
271	344	24	mm

art. N-143

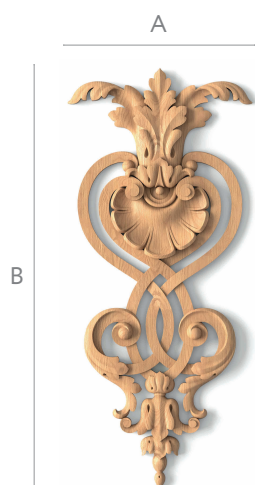

A	B	C	
80	183	10	mm
100	229	12	mm
130	297	16	mm
157	359	19	mm
190	434	23	mm

art. N-093

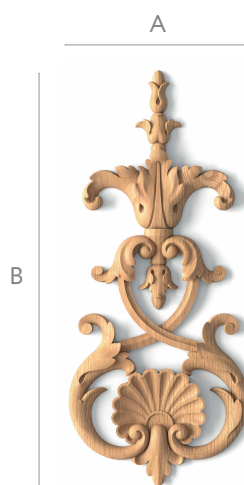

A	B	C	
80	185	9	mm
105	242	12	mm
133	300	15	mm
160	361	18	mm
200	451	23	mm

art. N-026.1

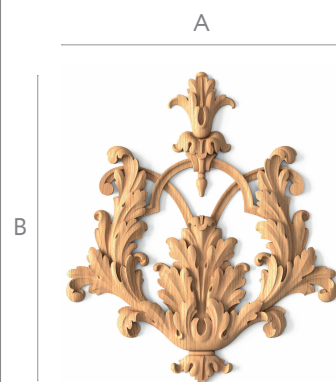

A	B	C	
170	197	11	mm
200	232	13	mm
240	278	15	mm

art. N-205



A	B	C	
250	84	10	mm
300	100	12	mm
350	117	14	mm
400	134	16	mm
450	150	18	mm
500	167	20	mm

art. N-117.1



A	B	C	
160	315	9	mm
200	394	11	mm
280	551	15	mm

art. N-237

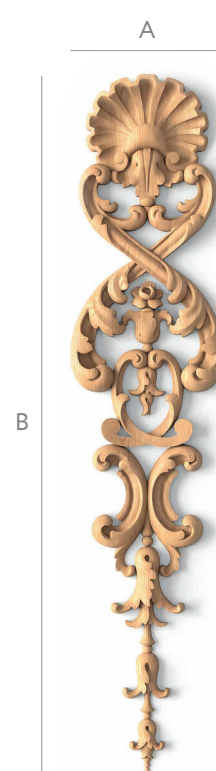

A	B	C	
70	315	15	mm
90	405	19	mm
110	495	23	mm
130	585	27	mm
150	675	31	mm

art. N-107

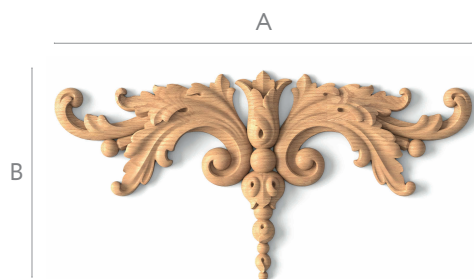

A	B	C	
200	101	11	mm
240	121	13	mm
290	146	16	mm
378	190	21	mm

art. N-122

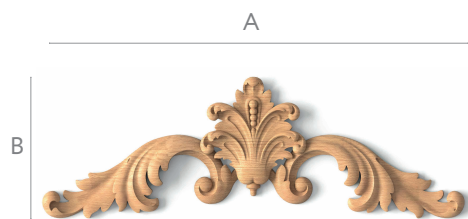

A	B	C	
222	74	11	mm
300	100	15	mm

art. N-008

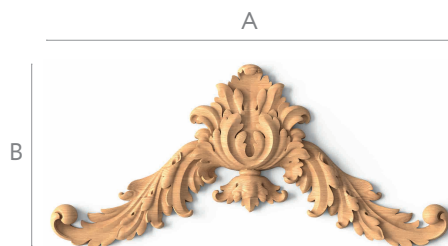

A	B	C	
210	97	12	mm
300	138	17	mm
350	161	20	mm

art. N-239



A	B	C	
165	40	8	mm
210	51	10	mm
270	66	12	mm
350	85	15	mm
450	110	19	mm

art. N-250



A	B	C	
280	90	12	mm
343	110	14	mm
404	130	17	mm
498	160	21	mm
557	179	23	mm
653	210	27	mm

art. N-251



A	B	C	
207	80	9	mm
259	100	12	mm
311	120	14	mm
389	150	17	mm
466	180	21	mm
516	200	23	mm

art. N-404



A	B	C	
635	275	35	mm
800	346	45	mm
1 000	433	55	mm

art. N-134



A	B	C	
220	113	11	mm
260	134	13	mm
310	159	16	mm
360	185	18	mm

art. N-157.1



A	B	C	
250	190	11	mm
350	265	15	mm
500	379	21	mm

art. N-276



A	B	C	
352	220	12	mm
517	323	18	mm
673	420	23	mm

art. N-154.1

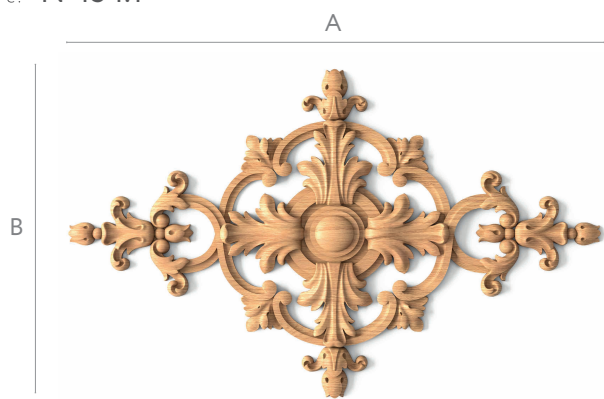

A	B	C	
200	124	9	mm
250	154	12	mm
300	185	14	mm
340	210	16	mm
420	259	18	mm

art. N-106

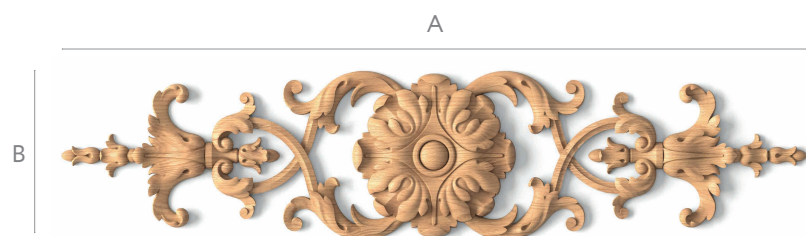

A	B	C	
311	70	8	mm
400	90	10	mm
488	110	13	mm
576	130	15	mm
665	150	17	mm

art. N-187

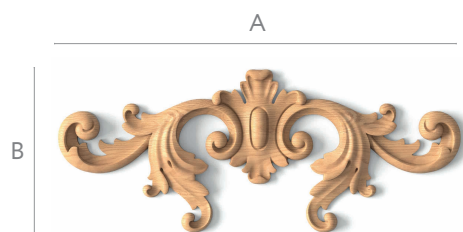

A	B	C	
180	73	10	mm
250	102	14	mm
350	142	20	mm

art. N-368

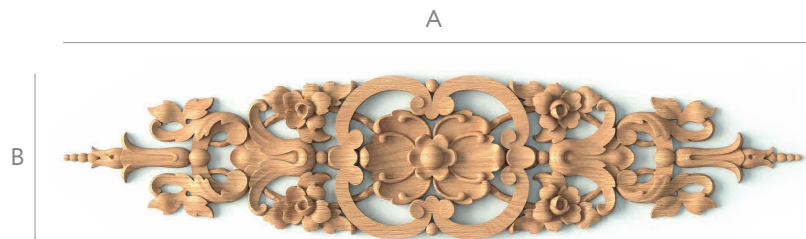

A	B	C	
300	67	9	mm
400	88	12	mm
517	114	16	mm



art. N-422

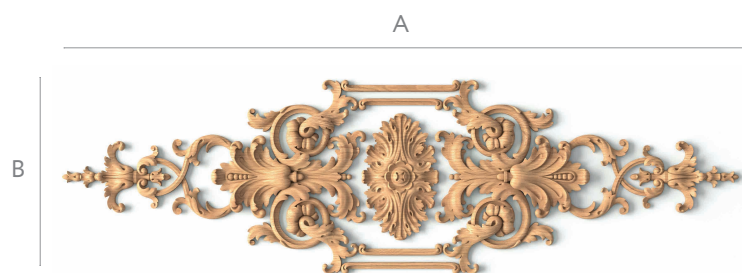

A	B	C	
790	225	16	mm
877	250	18	mm
965	275	20	mm

art. N-420

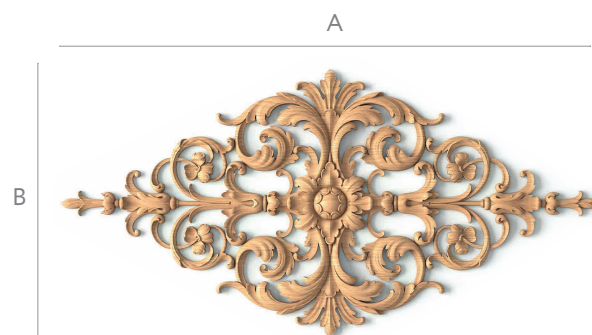

A	B	C	
502	250	14	mm
704	350	19	mm
814	405	21	mm

art. N-081



A	B	C	
35	116	7	mm
45	149	9	mm
50	166	10	mm
60	198	12	mm
70	232	15	mm

art. N-191

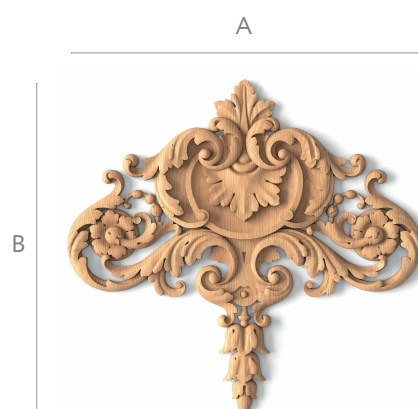

A	B	C	
210	197	12	mm
290	272	16	mm
380	356	21	mm

art. N-421

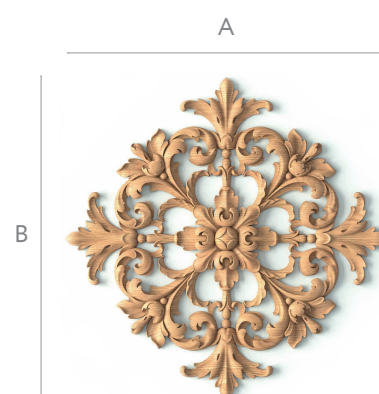

A	B	C	
250	250	13	mm
350	350	18	mm
405	405	21	mm

art. N-123



A	B	C	
250	41	11	mm
300	50	14	mm
350	58	16	mm
400	66	18	mm
500	83	23	mm

art. N-074

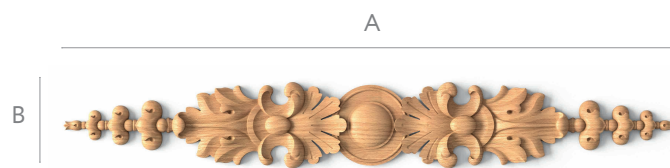

A	B	C	
253	35	8	mm
289	40	8	mm
325	45	9	mm
361	50	10	mm
431	60	12	mm
507	70	14	mm
579	80	16	mm

art. N-277



A	B	C	
568	249	17	mm
739	324	21	mm
910	398	26	mm
1137	498	33	mm

art. N-175

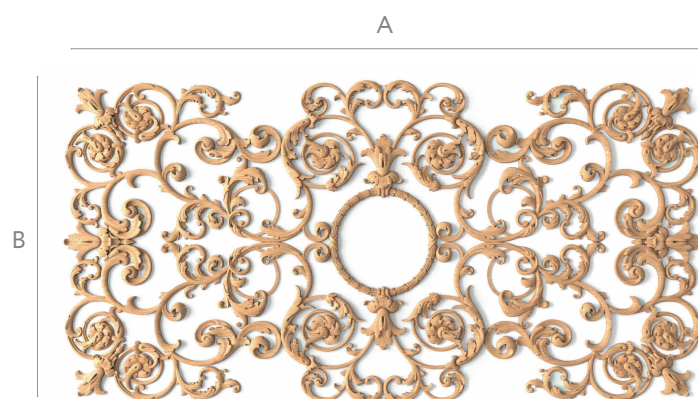

A	B	C	
988	500	13	mm
1185	600	16	mm
1450	734	19	mm

art. N-196

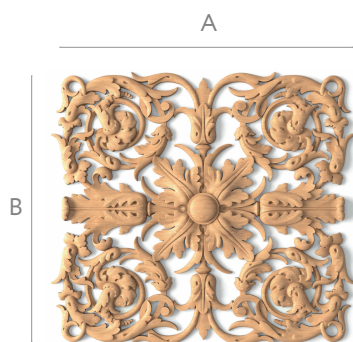

A	B	C	
250	224	13	mm
300	269	14	mm
350	314	17	mm
400	359	19	mm
450	404	21	mm
490	440	23	mm

art. N-319

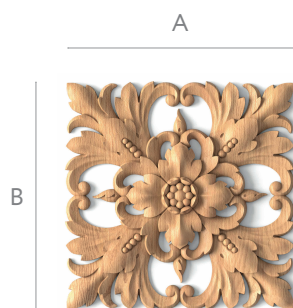

A	B	C	
240	240	21	mm
290	290	25	mm

art. N-040

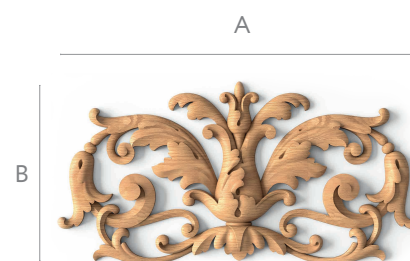

A	B	C	
170	86	13	mm
250	126	19	mm
350	176	27	mm

art. N-234L

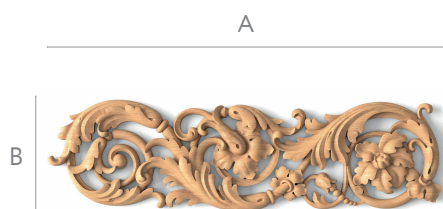

A	B	C	
283	80	13	mm
537	152	25	mm

art. N-234R

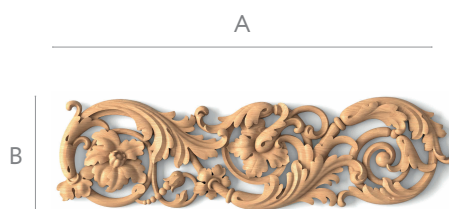

A	B	C	
283	80	13	mm
537	152	25	mm

art. N-098.1



A	B	C	
300	93	9	mm
400	124	12	mm
500	155	15	mm
600	186	18	mm

art. N-103

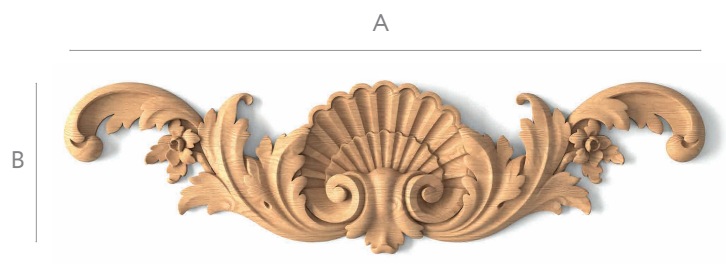

A	B	C	
500	134	25	mm
600	161	30	mm

art. N-204



A	B	C	
220	85	15	mm
300	116	19	mm
340	132	22	mm
450	174	28	mm
500	193	32	mm

art. N-165



A	B	C	
400	133	11	mm
490	163	14	mm
660	220	19	mm

art. N-125

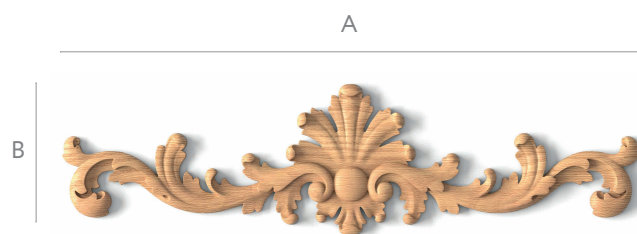

A	B	C	
250	65	9	mm
300	78	10	mm
400	104	14	mm
450	117	15	mm

art. N-101

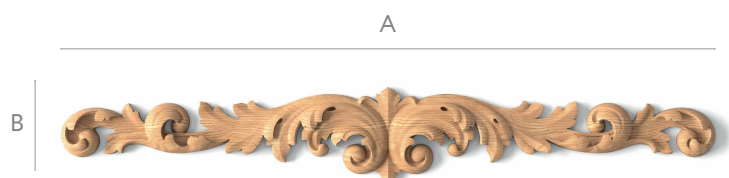

A	B	C	
450	66	14	mm
550	81	17	mm
750	111	22	mm

art. N-032



A	B	C	
200	43	8	mm
250	54	10	mm
350	76	15	mm
450	98	19	mm
550	119	23	mm

art. N-170.1



A	B	C	
400	51	10	mm
500	64	13	mm
580	74	15	mm
659	84	17	mm
750	96	19	mm

art. N-214

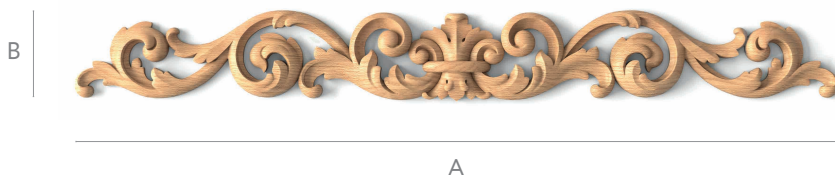

A	B	C	
338	40	12	mm
423	50	14	mm
507	60	16	mm
592	70	19	mm
676	80	22	mm

art. N-148

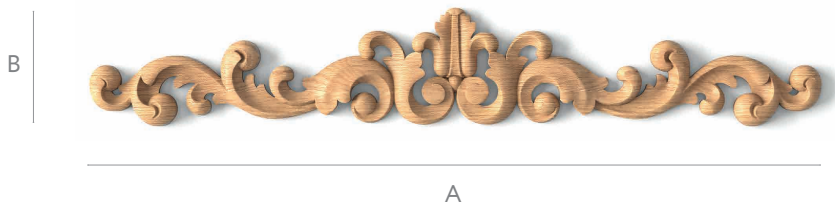

A	B	C	
250	40	9	mm
350	56	12	mm
550	89	19	mm

art. N-270

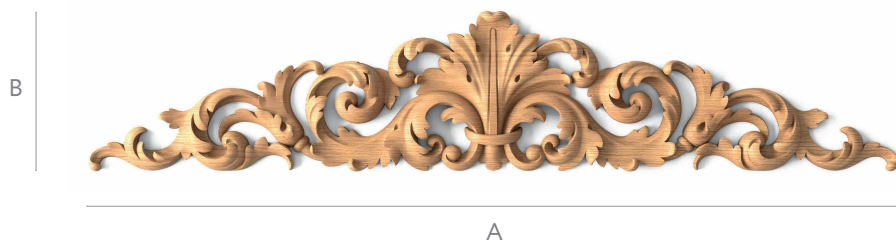

A	B	C	
356	70	11	mm
432	85	13	mm
560	110	16	mm
611	120	18	mm
712	140	21	mm
865	170	26	mm
1 018	200	31	mm

art. N-269

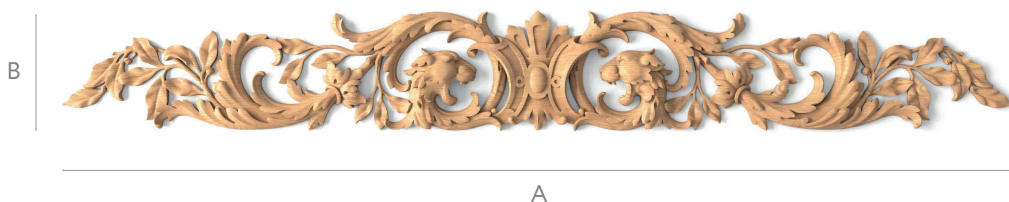

A	B	C	
636	80	18	mm
795	100	22	mm
955	120	26	mm
1 114	140	30	mm
1 273	160	34	mm

art. N-359



A	B	C	
700	98	15	mm
1 000	139	22	mm

art. N-439



A	B	C	
500	138	18	mm
600	165	22	mm
700	193	26	mm
800	220	30	mm

art. N-173.1



A	B	C	
500	110	19	mm
600	132	22	mm
700	154	26	mm
800	176	30	mm
900	198	34	mm
1 000	220	38	mm

art. N-092



A	B	C	
293	50	10	mm
352	60	12	mm
410	70	13	mm
469	80	15	mm
527	90	17	mm
600	102	21	mm
800	137	25	mm

art. N-034



A	B	C	
400	99	17	mm
500	124	21	mm
600	149	25	mm
700	174	29	mm
800	199	33	mm

art. N-268



A	B	C	
847	120	20	mm
1 058	150	25	mm
1 300	184	30	mm

art. N-217

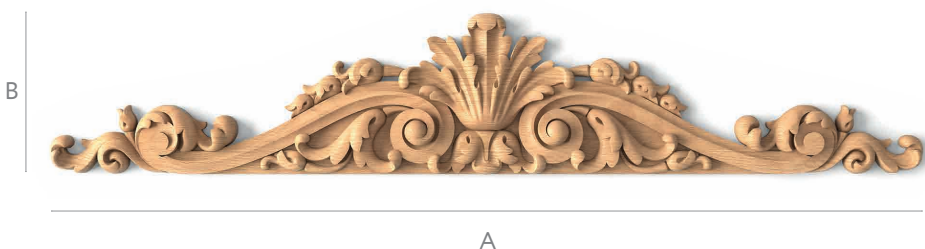

A	B	C	
400	73	16	mm
500	91	19	mm
600	109	23	mm
700	128	26	mm
800	146	31	mm
900	164	35	mm
1 000	182	39	mm

art. N-240



A	B	C	
267	35	7	mm
420	55	11	mm
535	70	14	mm

A

art. N-056



A	B	C	
550	70	14	mm
650	83	16	mm

A

art. N-076



A	B	C	
602	92	11	mm
936	140	17	mm

A

art. N-246



A	B	C	
660	85	22	mm
854	110	28	mm
970	125	32	mm

A

art. N-248



A	B	C	
563	100	15	mm
677	120	17	mm
789	140	20	mm
913	162	23	mm
1 014	180	25	mm

A

art. N-249



A	B	C	
397	90	10	mm
574	130	12	mm
705	160	15	mm
838	190	18	mm
948	215	20	mm
1 103	250	23	mm

A

art. N-176

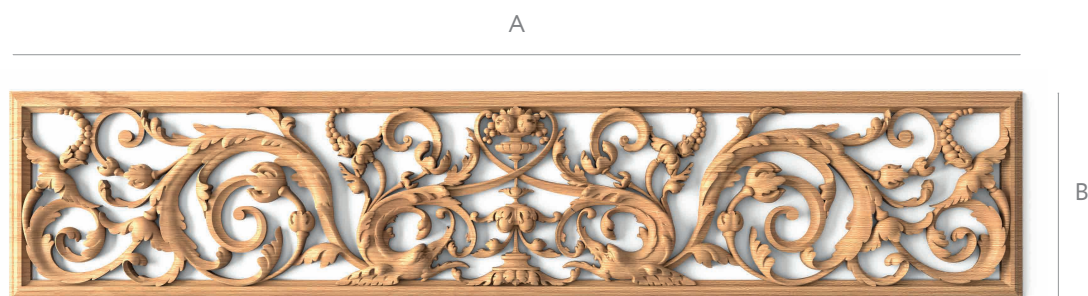

A	B	C	
918	190	26	mm
1160	240	33	mm
1397	289	40	mm

art. N-060



A	B	C	
933	188	18	mm
1237	250	24	mm
1731	350	34	mm

art. N-177L

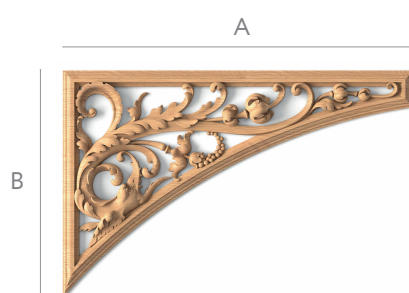

A	B	C	L	
278	180	17	316	mm
339	220	21	386	mm
401	260	25	456	mm
463	300	29	527	mm
540	350	34	614	mm
637	413	40	725	mm

art. N-177R

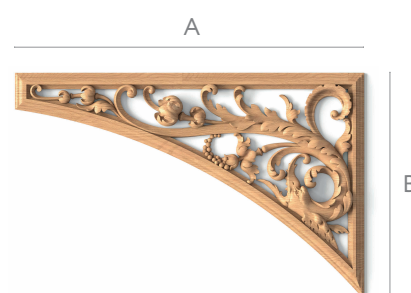

A	B	C	L	
278	180	17	316	mm
339	220	21	386	mm
401	260	25	456	mm
463	300	29	527	mm
540	350	34	614	mm
637	413	40	725	mm

art. N-060-1

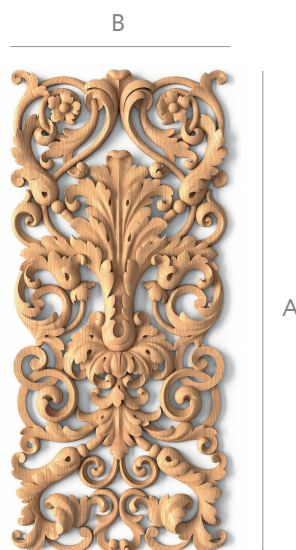

A	B	C	
419	188	18	mm
557	250	20	mm
779	350	24	mm

art. N-060-2

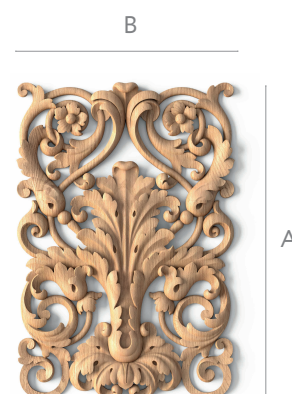

A	B	C	
364	250	20	mm
509	350	24	mm



art. N-095



A	B	C	
600	209	19	mm
700	244	22	mm
800	279	25	mm

art. N-182



A

A	B	C	
400	276	17	mm
500	345	21	mm
600	414	26	mm
740	511	31	mm

art. N-441L

art. N-441R



A

A	B	C	L	
428	227	13	476	mm
500	265	15	556	mm
571	303	17	635	mm

art. N-442L

art. N-442R



A

B

A	B	C	L	
680	227	13	710	mm
795	265	15	830	mm
909	303	17	949	mm

art. N-440L

art. N-440R



B

A	B	C	L	
300	227	13	367	mm
350	265	15	428	mm
400	303	17	490	mm

art. N-355L



A	B	C	
1500	300	13	mm

art. N-355R



A	B	C	
1500	300	13	mm

art. N-354L



A	B	C	
1800	600	26	mm
2100	750	30	mm

art. N-354R



A	B	C	
1800	600	26	mm
2100	750	30	mm

art. N-367



A	B	C	
1061	284	18	mm
1454	390	24	mm

art. N-356L

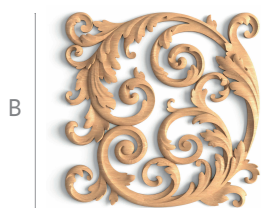

A	B	C	
300	300	13	mm
400	400	17	mm
500	500	22	mm
600	600	26	mm
700	700	30	mm

art. N-356R

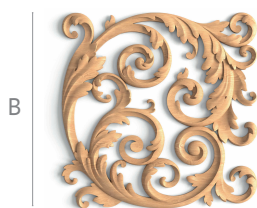

A	B	C	
300	300	13	mm
400	400	17	mm
500	500	22	mm
600	600	26	mm
700	700	30	mm

art. N-365



A	B	C	
500	285	21	mm
685	390	27	mm

art. N-366



A	B	C	
337	283	22	mm
463	388	30	mm



art. N-028.1

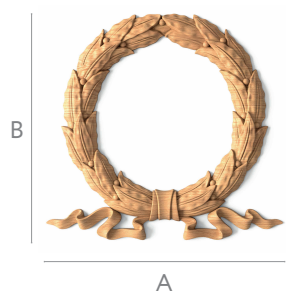

A	B	C	
160	153	9	mm
200	191	12	mm
300	286	17	mm
350	334	20	mm

art. N-150

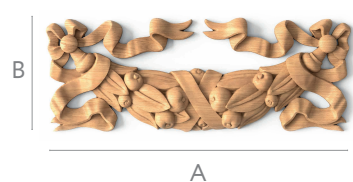

A	B	C	
150	55	13	mm
220	80	19	mm
300	110	25	mm

art. N-030

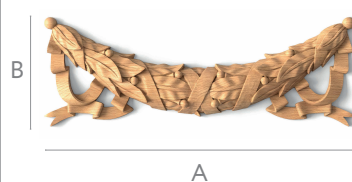

A	B	C	
220	77	17	mm
300	105	23	mm
350	122	27	mm
400	140	31	mm

art. N-029

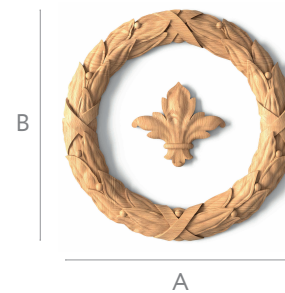

A	B	C	
150	150	12	mm
200	200	16	mm
304	304	25	mm

art. N-172

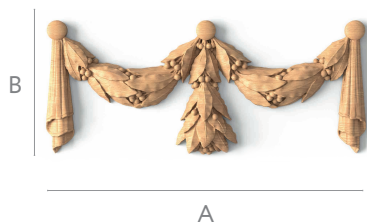

A	B	C	
250	104	18	mm
400	167	29	mm
494	206	36	mm

art. N-031

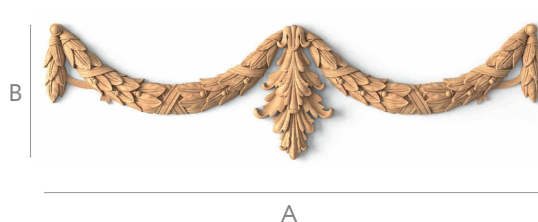

A	B	C	
500	136	16	mm
700	190	23	mm

art. N-353

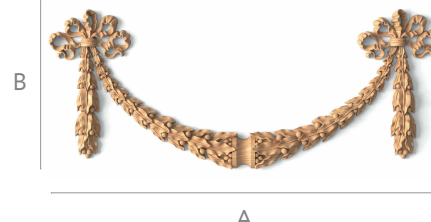

A	B	C	
300	122	11	mm
400	163	14	mm
500	204	18	mm

art. N-079-2

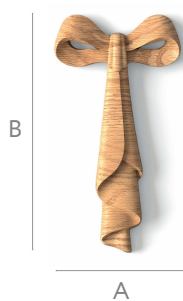

A	B	C	
30	56	6	mm
45	85	9	mm
57	107	11	mm

art. N-078

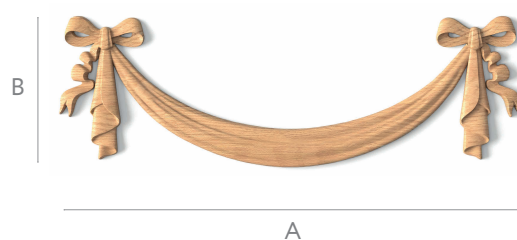

A	B	C	
184	60	6	mm
276	90	8	mm
350	114	10	mm

art. N-079-1

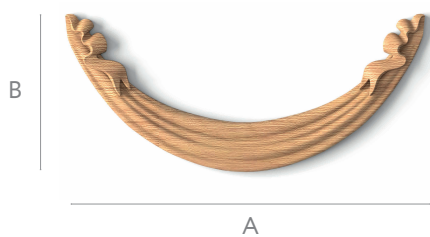

A	B	C	
111	49	6	mm
166	73	9	mm
211	93	11	mm

art. N-079-1 + art. N-079-2



art. N-124



A	B	C	
600	149	16	mm
700	174	19	mm
837	208	23	mm

art. N-045

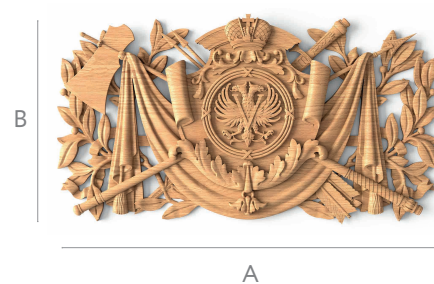

A	B	C	
419	228	28	mm
520	283	35	mm
620	337	41	mm

art. N-127

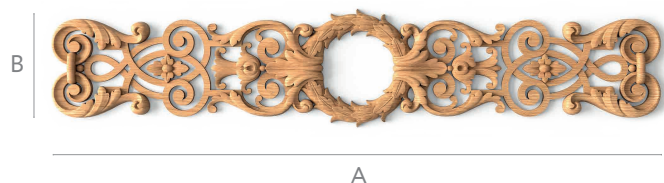

A	B	C	
450	88	11	mm
550	107	13	mm
650	127	15	mm
722	141	17	mm
850	166	20	mm

art. N-278



A	B	C	
728	110	18	mm
992	150	24	mm

art. N-376

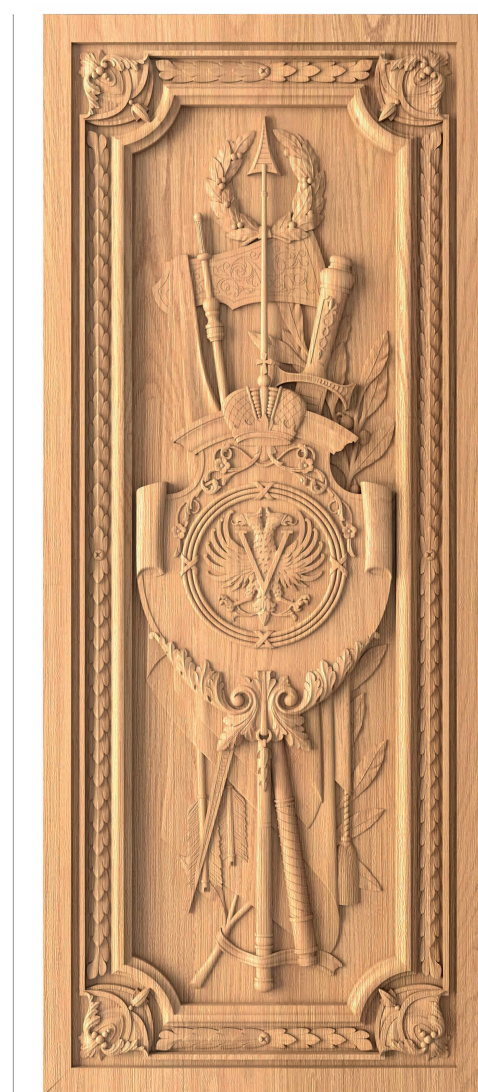

A	B	C	
1040	425	30	mm

art. N-051.1

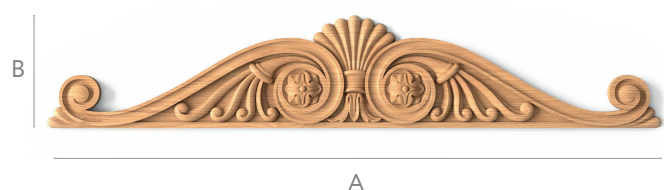

A	B	C	
450	82	13	mm
500	92	14	mm
550	101	16	mm
600	110	17	mm
650	119	19	mm
737	135	21	mm
800	147	23	mm

art. N-374



A	B	C	
180	797	55	mm
210	930	65	mm
237	1050	73	mm

art. N-183

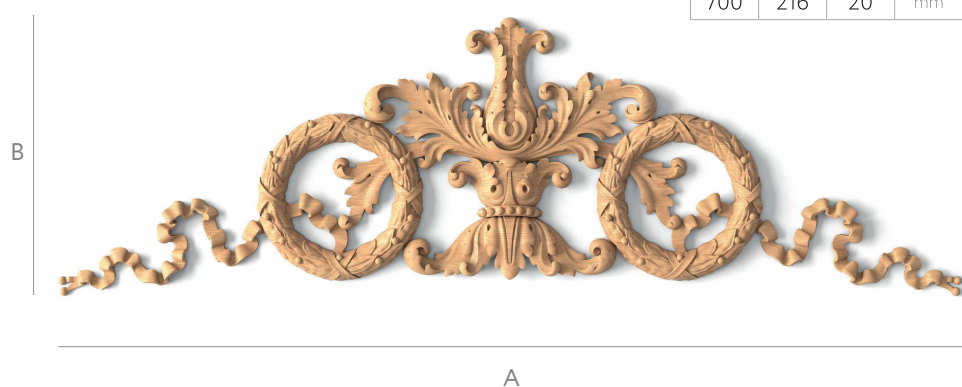

A	B	C	
700	216	20	mm

art. N-243

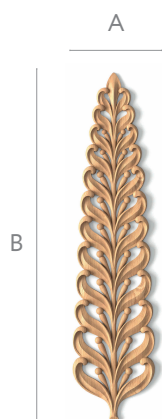

A	B	C	
50	215	6	mm
70	301	8	mm
100	431	13	mm

art. N-279

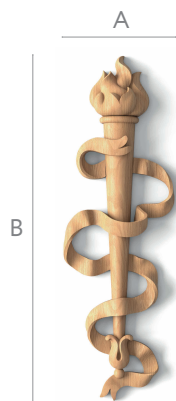

A	B	C	
60	187	18	mm
80	249	23	mm
110	342	32	mm

art. N-116

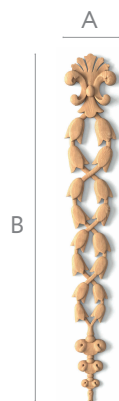

A	B	C	
45	302	10	mm
55	369	12	mm
70	470	15	mm

art. N-236

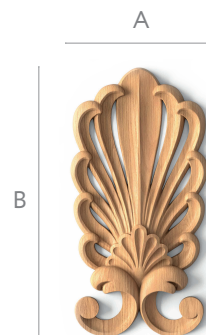

A	B	C	
55	108	10	mm
90	176	17	mm

art. N-223



A	B	C	
201	40	9	mm
252	50	11	mm
302	60	13	mm
352	70	15	mm
402	80	17	mm

art. N-071



A	B	C	
201	40	9	mm
302	60	13	mm
352	70	15	mm

art. N-073



A	B	C	
633	45	10	mm
774	55	12	mm
985	70	15	mm

art. N-185



A	B	C	
322	30	8	mm
430	40	11	mm
537	50	14	mm
752	70	18	mm

art. N-318L art. N-318R

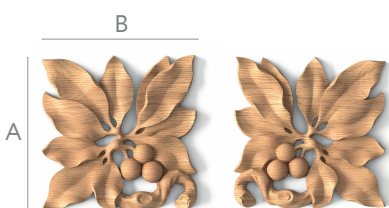

A	B	C	
50	50	7	mm
65	65	9	mm
87	87	12	mm

art. N-317



A	B	C	
402	50	10	mm
700	87	17	mm
805	100	20	mm

art. N-348

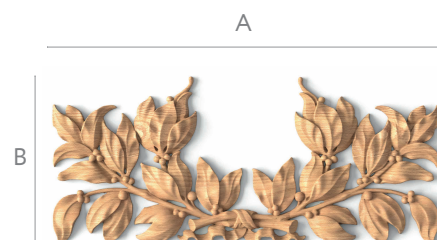

A	B	C	
370	160	16	mm
550	237	23	mm

art. N-419

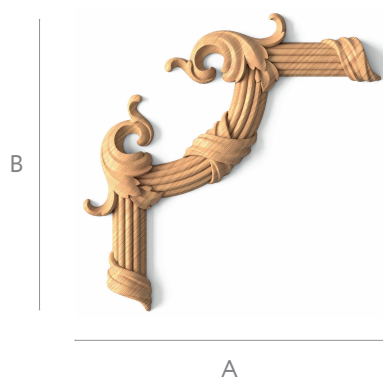

A	B	C	L	
175	175	14	175	mm



art. N-419
 art. N-418
 art. K-094L
 art. K-094R



art. N-419
 art. N-418
 art. K-095

art. N-418

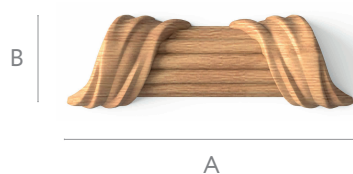

A	B	C	
82	27	14	mm





art. N-462.1

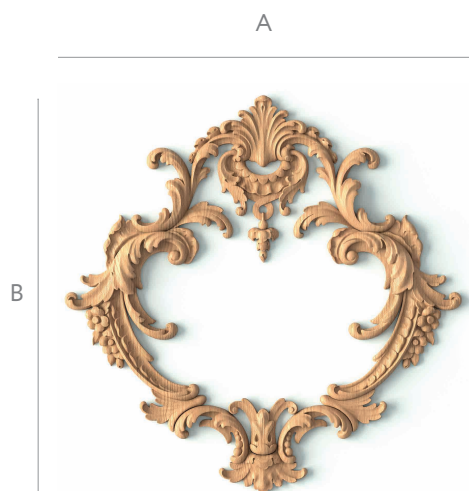

A	B	C	
330	330	14	mm
400	400	17	mm

art. N-463.1



A	B	C	
330	260	12	mm
400	315	15	mm

art. N-465



A	B	C	
330	190	12	mm
400	230	15	mm

art. N-464



A	B	C	
300	420	15	mm
350	490	17	mm

art. N-475



A	B	C	
350	180	16	mm

art. N-478

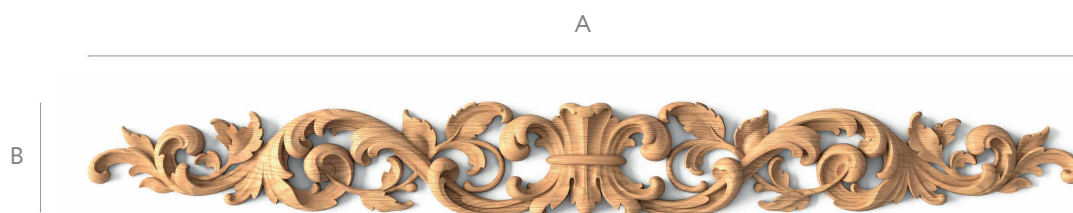

A	B	C	
400	47	13	mm
500	59	16	mm
600	71	19	mm



art. N-467L



A	B	C	
250	135	14	mm

art. N-467R



A	B	C	
250	135	14	mm

art. N-468L



A	B	C	
285	152	15	mm

art. N-468R



A	B	C	
285	152	15	mm

art. N-469L

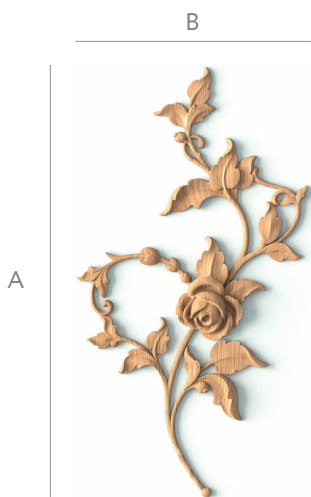

A	B	C	
320	170	19	mm

art. N-469R



A	B	C	
320	170	19	mm

art. N-472L



A	B	C	
190	75	7	mm

art. N-472R

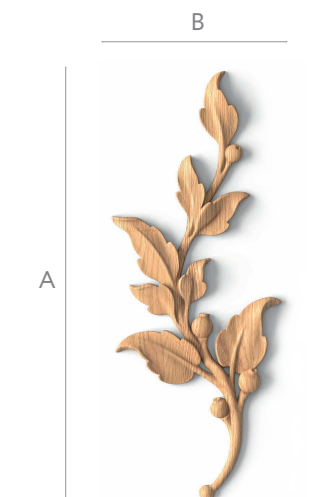

A	B	C	
190	75	7	mm

art. N-471L



A	B	C	
135	85	8	mm

art. N-471R



A	B	C	
135	85	8	mm

art. N-470L

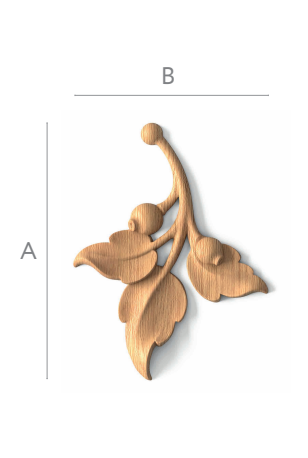

A	B	C	
80	60	8	mm

art. N-470R

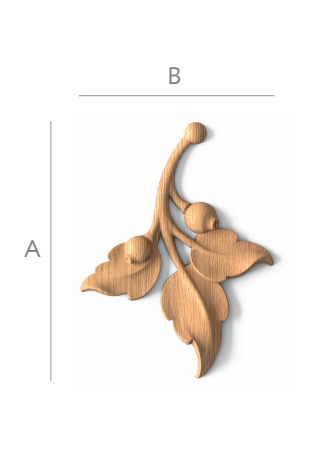

A	B	C	
80	60	8	mm



art. N-462.2

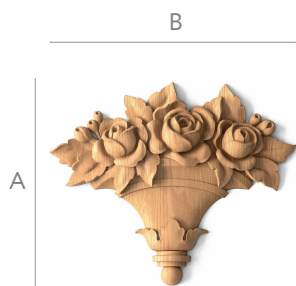

A	B	C	
115	140	19	mm
140	170	23	mm

art. N-463.2

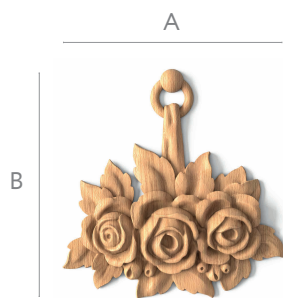

A	B	C	
105	110	16	mm
130	135	19	mm

art. N-473



A	B	C	
100	70	20	mm

art. N-474

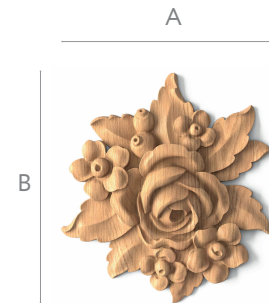

A	B	C	
105	115	20	mm

art. N-476L

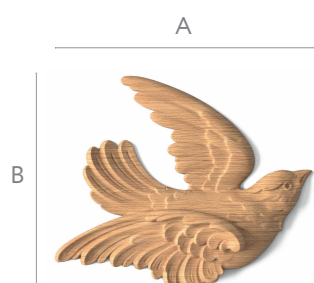

A	B	C	
115	95	17	mm

art. N-476R



A	B	C	
115	95	17	mm

art. N-477L



A	B	C	
100	70	12	mm

art. N-477R

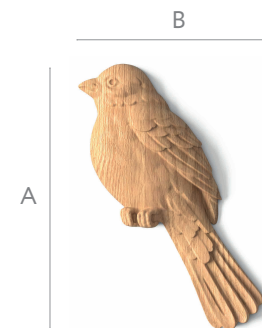

A	B	C	
100	70	12	mm

art. C-047

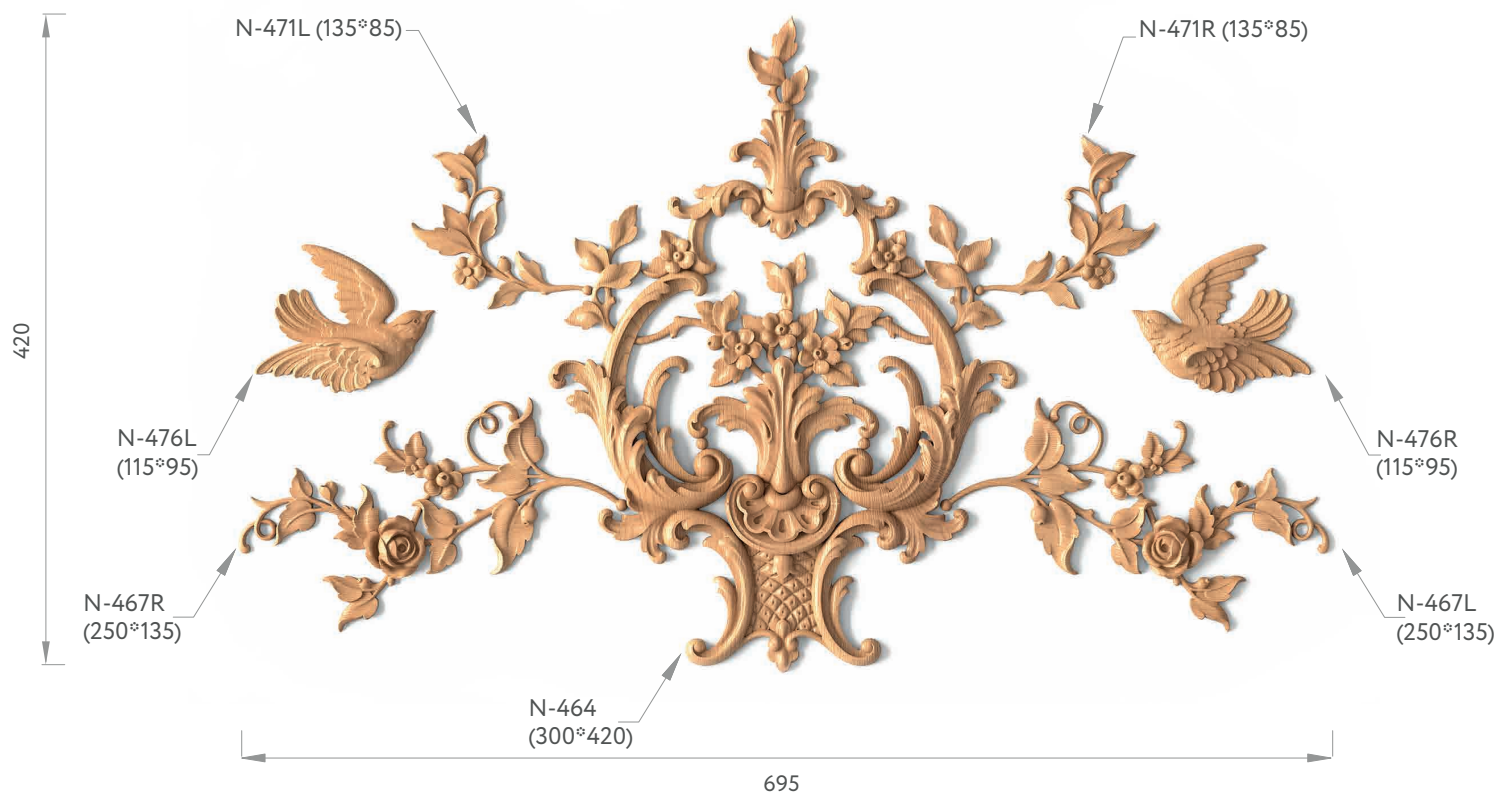

A	B	C	
695	420	14	mm



art. N-482L

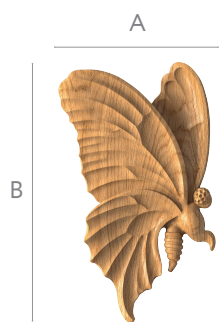

A	B	C	
56	93	15	mm

art. N-482R

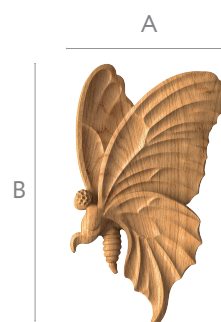

A	B	C	
56	93	15	mm

art. N-481

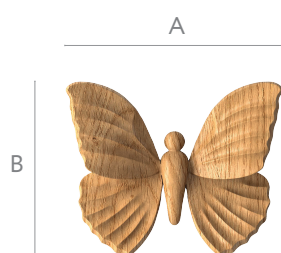

A	B	C	
41	33	8	mm

art. NPU-489

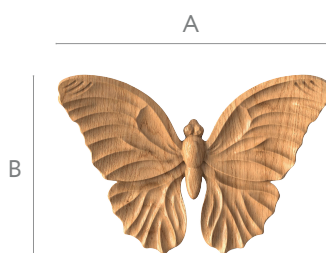

A	B	C	
80	53	16	mm

art. N-479

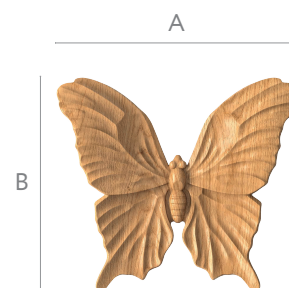

A	B	C	
96	84	17	mm

art. N-486

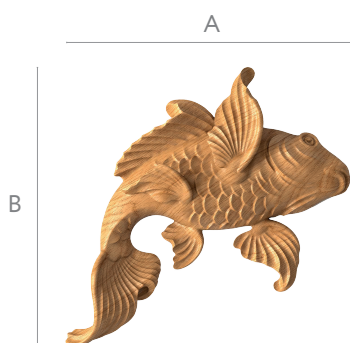

A	B	C	
118	84	19	mm

art. N-483L

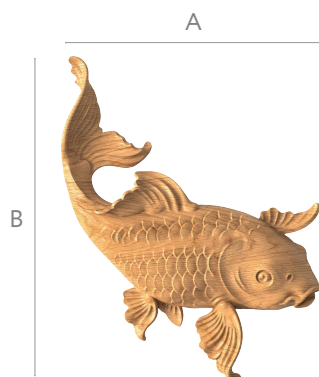

A	B	C	
135	84	17	mm

art. N-483R

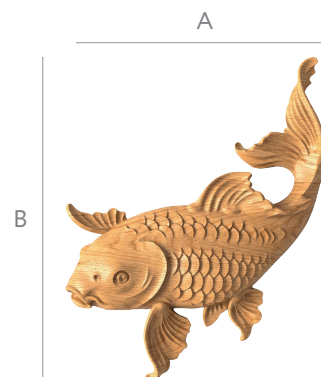

A	B	C	
135	84	17	mm

art. N-484

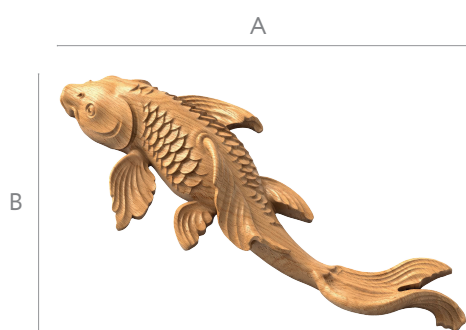

A	B	C	
181	68	24	mm

art. N-487

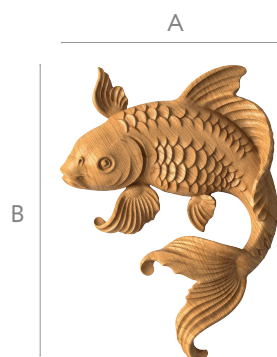

A	B	C	
134	96	18	mm

art. N-488

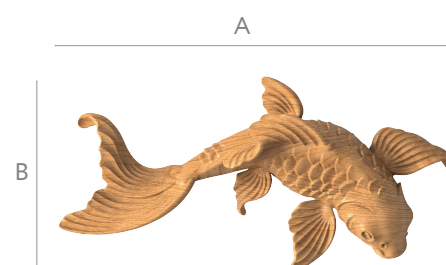

A	B	C	
144	72	21	mm



art. N-480

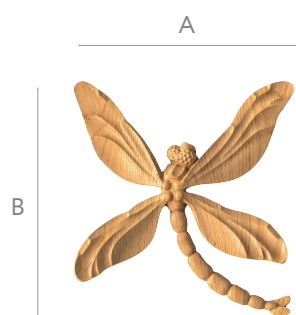

A	B	C	
77	82	13	mm

art. N-485

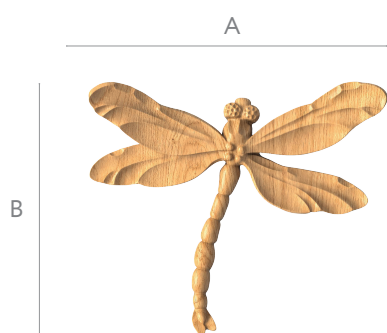

A	B	C	
96	82	15	mm



art. N.VRS-002-4L



A	B	C	
109	91	9	mm

art. N.VRS-001-1

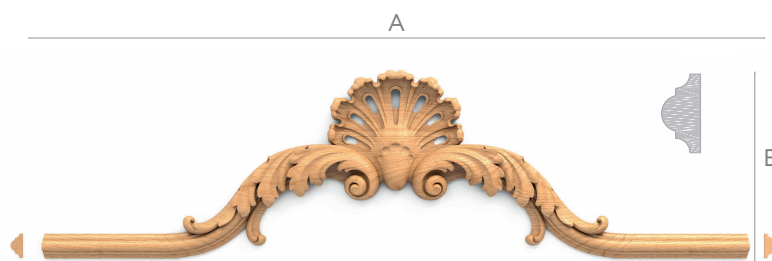

К размеру 635*168*22
подходит молдинг MLD-002

A	B	C	
635	168	22	mm

art. N.VRS-002-4R



A	B	C	
109	91	9	mm

art. N.VRS-003-2L
Уголок на молдинг MLD-001

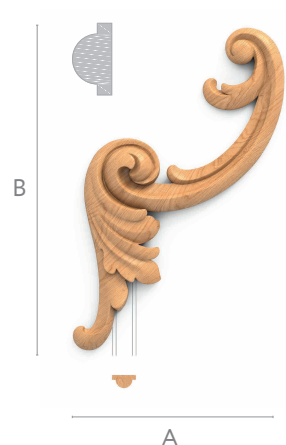

A	B	C	
136	89	15	mm

art. N.VRS-003

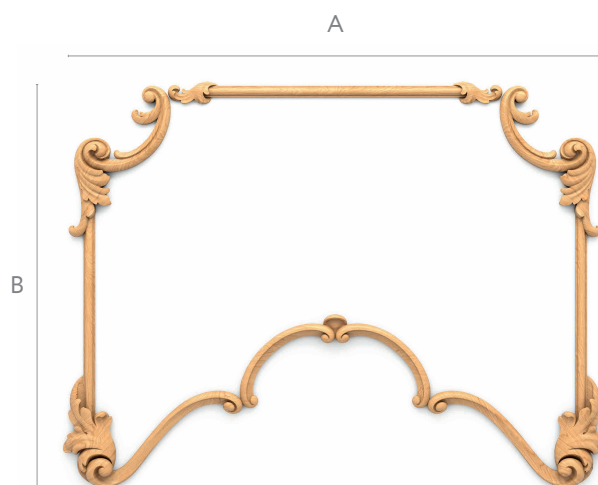

A	B	C	
476	364	16	mm

art. N.VRS-003-2R
Уголок на молдинг MLD-001

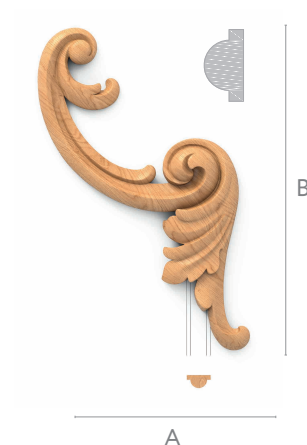

A	B	C	
136	89	15	mm

art. N.VRS-008L
Наконечник на молдинг MLD-001

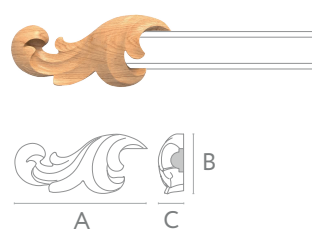

A	B	C	
45	20	9	mm

art. N.VRS-002-1



К размеру 645*153*22
подходит молдинг MLD-002

A	B	C	
645	153	22	mm

art. N.VRS-008R
Наконечник на молдинг MLD-001

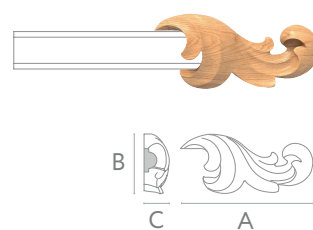

A	B	C	
45	20	9	mm



art. C.VRS-057

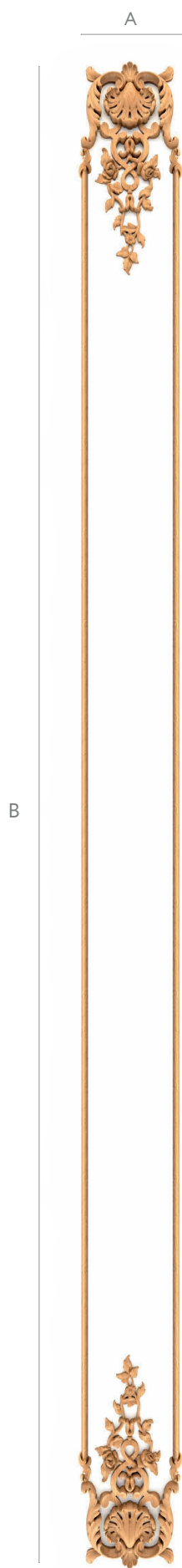

A	B	C	
157	2312	16	mm

art. C.VRS-058

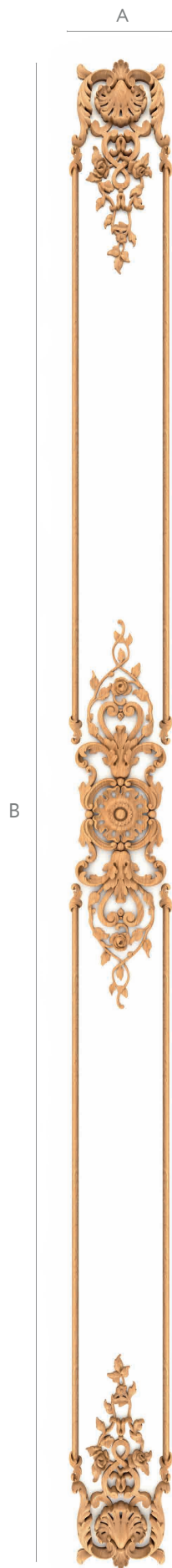

A	B	C	
157	2300	16	mm

art. N.VRS-004

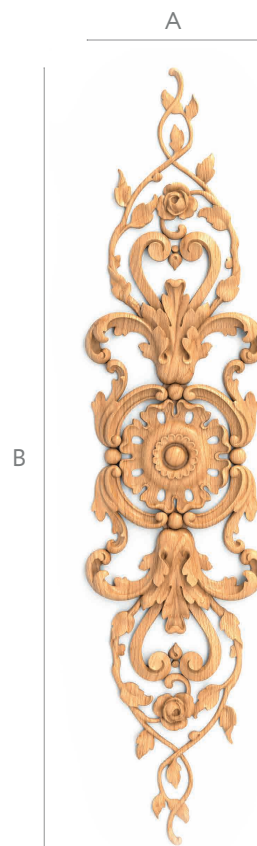

A	B	C	
139	596	15	mm

art. N.VRS-005

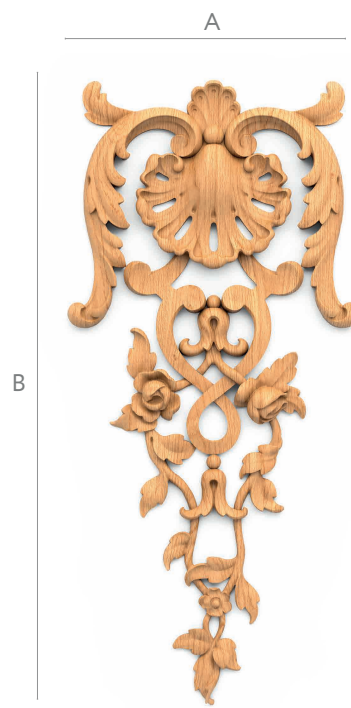

A	B	C	
150	321	16	mm



art. C.VRS-056

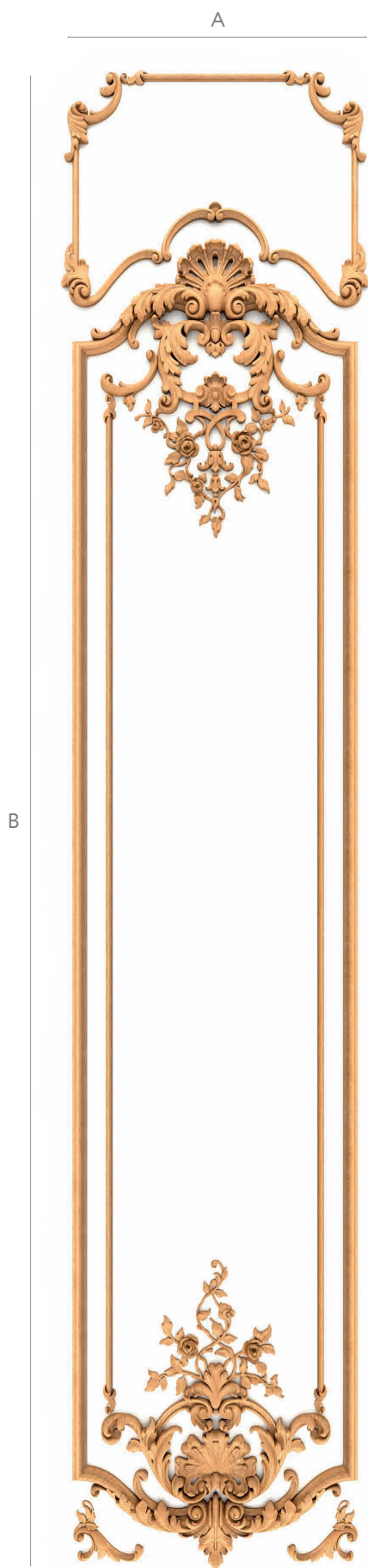

A	B	C	
475	2312	22	mm

art. C.VRS-059

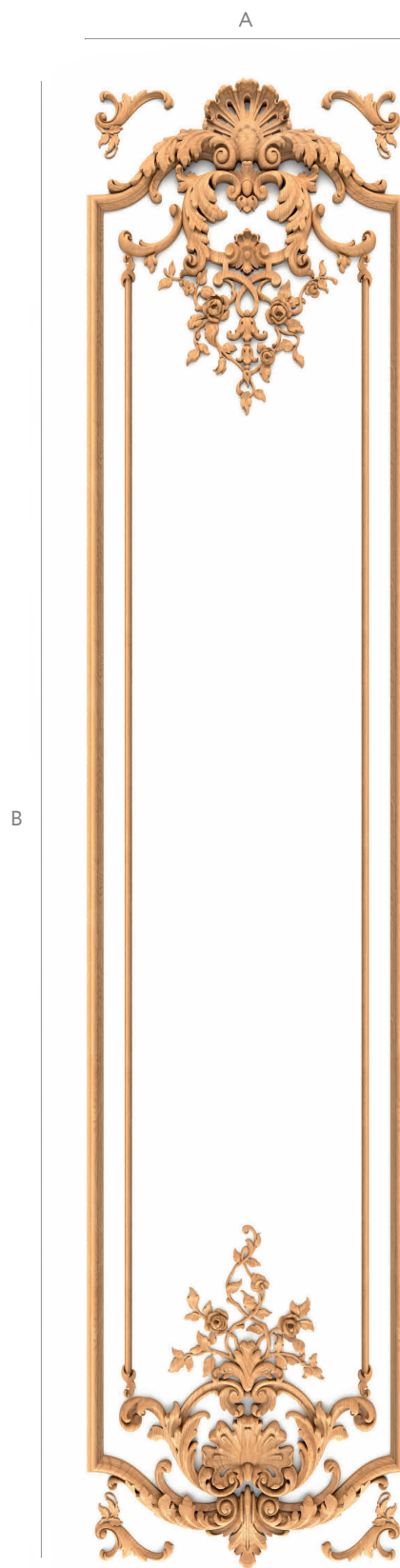

A	B	C	
441	2040	22	mm

art. N.VRS-001

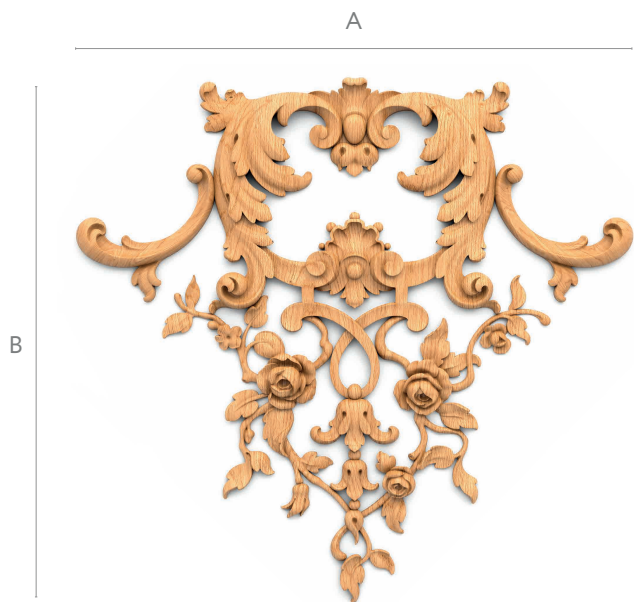

A	B	C	
355	342	17	mm

art. N.VRS-002

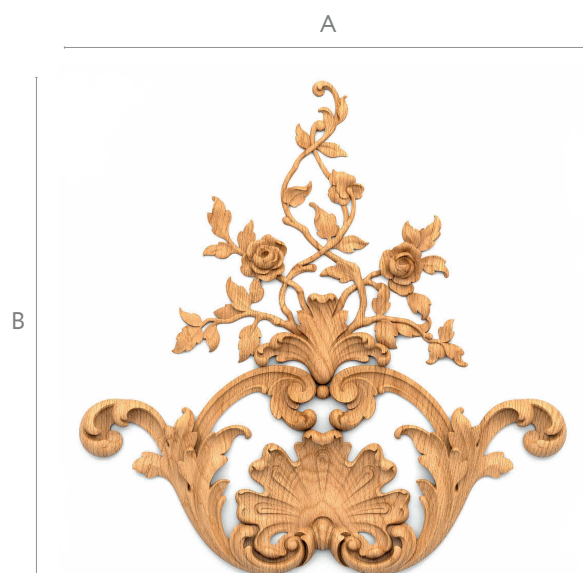

A	B	C	
354	368	19	mm



art. C.VRS-061

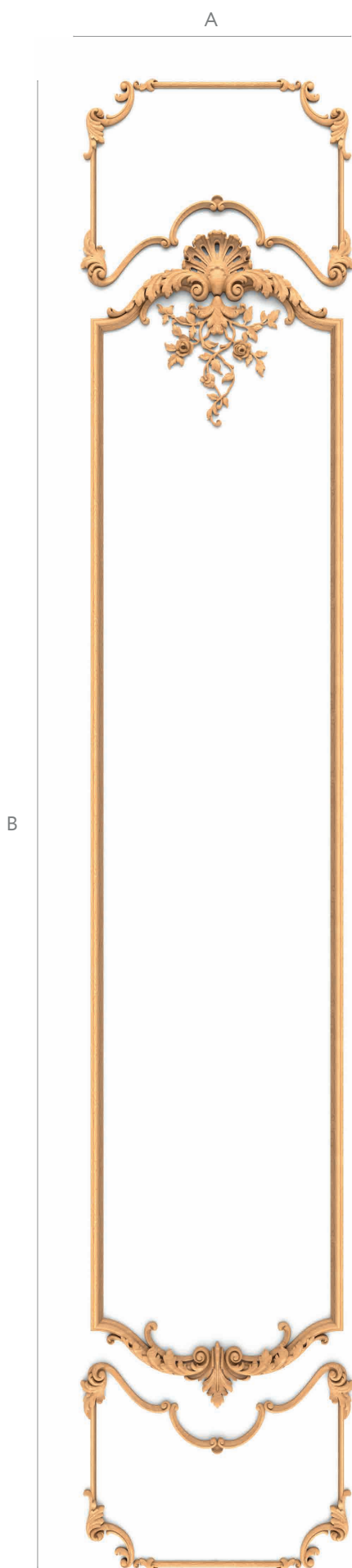

A	B	C	
476	2600	22	mm

art. C.VRS-062

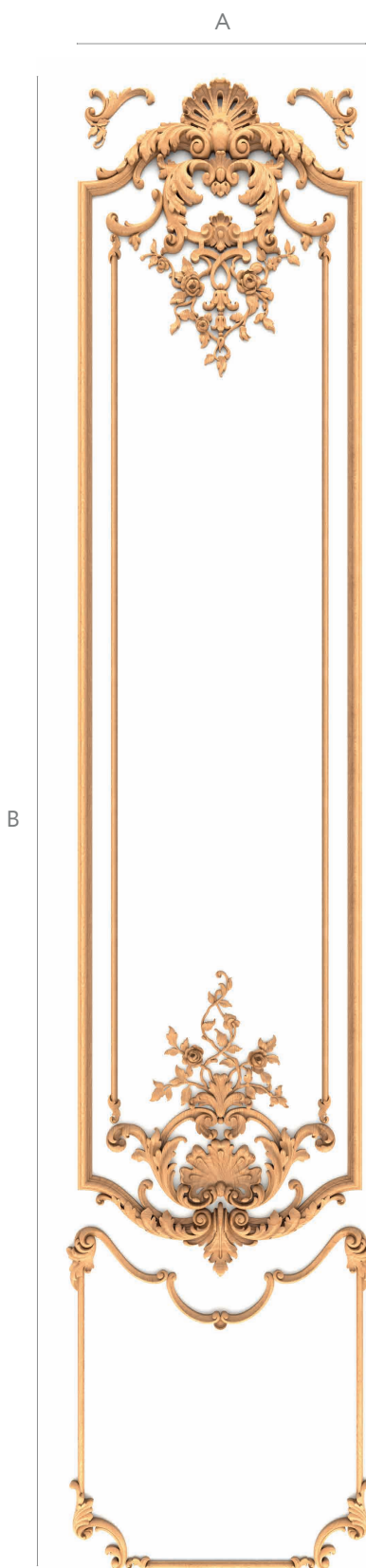

A	B	C	
475	2300	22	mm

art. N.VRS-002-3

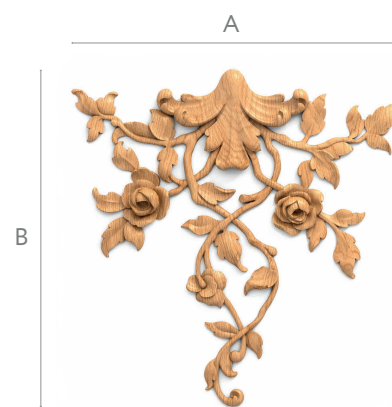

A	B	C	
217	227	13	mm

art. C.VRS-060

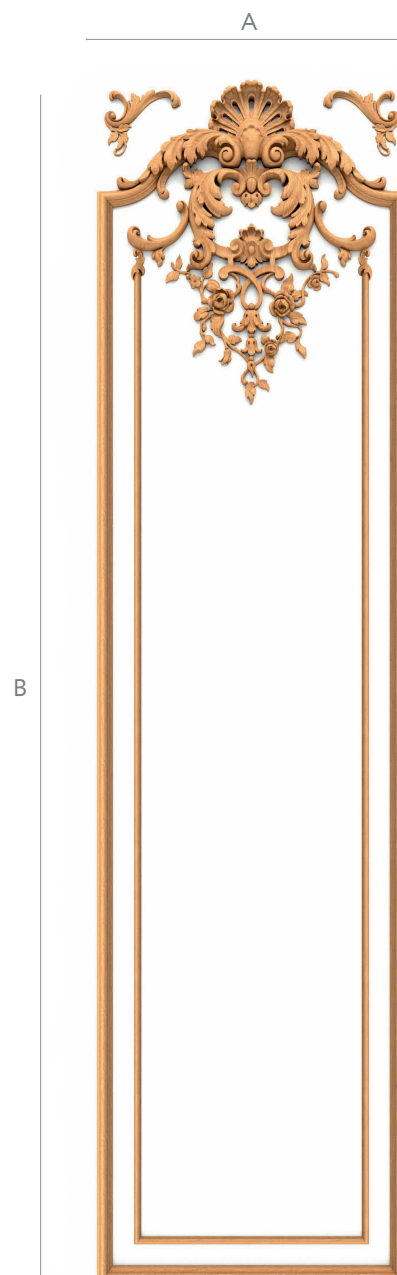

A	B	C	
441	1700	22	mm



art. C.VRS-055



A	B	C	
1550	460	23	mm

art. C.VRS-064

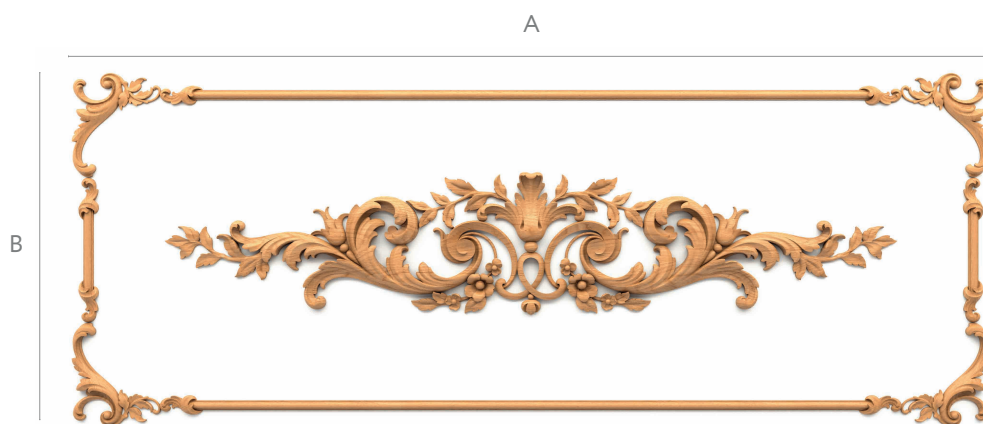

A	B	C	
1550	460	23	mm

art. N.VRS-014R

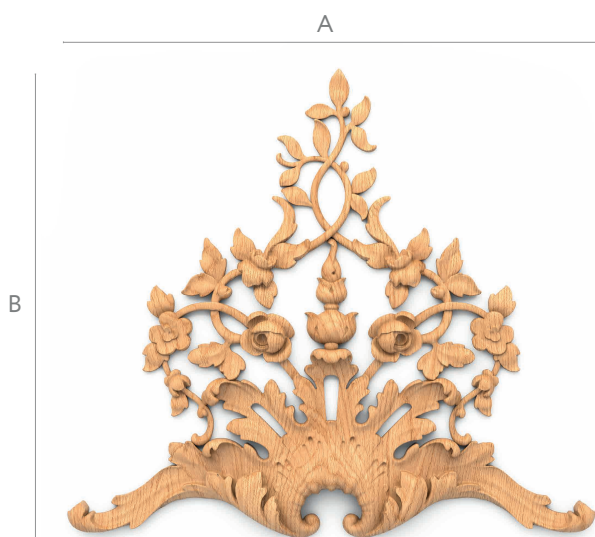

A	B	C	
335	300	21	mm

art. N.VRS-014L

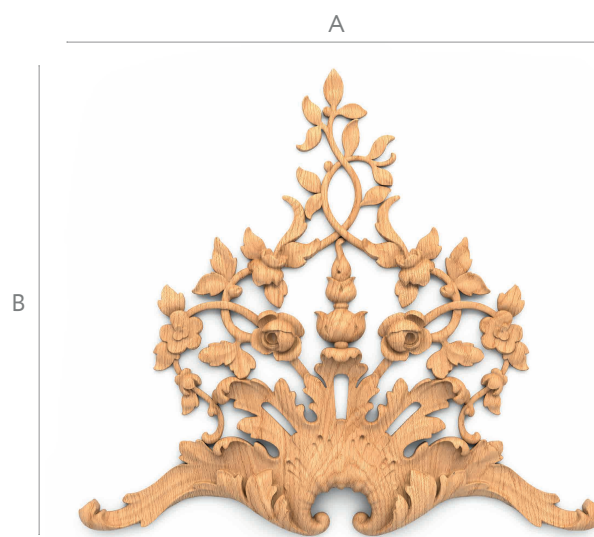

A	B	C	
335	300	21	mm

art. N.VRS-006



A	B	C	
1067	352	23	mm

art. N.VRS-012

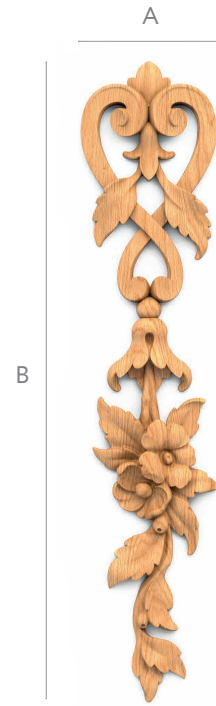

A	B	C	
55	254	11	mm

art. N.VRS-013



A	B	C	
768	149	18	mm



art. M-006



A B

A	B	C	
65	65	33	mm
80	80	41	mm
100	100	51	mm
120	120	62	mm
150	150	77	mm
190	190	97	mm
230	230	118	mm
300	300	154	mm

art. M-017



A B

A	B	C	
100	100	65	mm
150	150	98	mm
200	200	131	mm
250	250	163	mm
300	300	196	mm

art. M-009



A B

A	B	C	
100	100	26	mm
120	120	32	mm
150	150	39	mm
190	190	50	mm
240	240	63	mm

art. M-018



A B

A	B	C	
85	80	26	mm
127	120	39	mm
180	170	56	mm
233	220	72	mm

art. M-014



A B

A	B	C	
121	85	42	mm
142	100	47	mm
170	120	59	mm
213	150	73	mm
247	174	85	mm
298	210	103	mm

art. M-015



A B

A	B	C	
126	100	30	mm
152	120	37	mm
189	150	46	mm
236	187	57	mm
278	220	67	mm
379	300	91	mm

art. M-012



A B

A	B	C	
135	90	39	mm
165	110	48	mm
195	130	57	mm
240	160	70	mm
300	200	88	mm

art. M-010



B

A	B	C	
90	90	37	mm
110	110	45	mm
135	135	55	mm
160	160	65	mm
190	190	77	mm
230	230	93	mm

art. M-002



B

A	B	C	
75	75	25	mm
90	90	30	mm
120	120	40	mm
150	150	50	mm
208	208	69	mm
250	250	83	mm
300	300	100	mm
400	400	133	mm

art. M-011



B

A	B	C	
131	100	34	mm
171	130	44	mm
210	160	54	mm
269	205	69	mm
328	250	84	mm

art. M-019



B

A	B	C	
131	100	52	mm
209	160	83	mm
301	230	119	mm





Ценителям мастерства

Оформить заказ вы можете на сайте или по телефону:

8 (800) 555-46-75



stavros.ru